

SHARP®

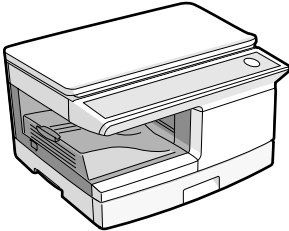

DIGITAL MULTIFUNCTIONAL SYSTEM

OPERATION MANUAL (for general information)



	Page
PREPARATIONS	9
LOADING PAPER	14
MAKING COPIES	20
CONVENIENT COPY FUNCTIONS	26
INSTALLING THE SOFTWARE	36
PRINTER/SCANNER FUNCTIONS	49
USER SETTINGS	54
TROUBLESHOOTING AND MAINTENANCE	61
OPTIONAL EQUIPMENT	80
APPENDIX	82

Each instruction also covers the optional units used with this product.

In some areas, the "POWER" switch positions are marked "I" and "O" on the copier instead of "ON" and "OFF".

If your copier is so marked, please read "I" for "ON" and "O" for "OFF".

Caution!

For a complete electrical disconnection, pull out the main plug.

The socket-outlet shall be installed near the equipment and shall be easily accessible.

Shielded interface cables must be used with this equipment to maintain compliance with EMC regulations.

Do not make copies of anything which is prohibited from copying by law. The following items are normally prohibited from copying by national law. Other items may be prohibited by local law.

- Money
- Stamps
- Bonds
- Stocks
- Bank drafts
- Checks
- Passports
- Driver's licences

CONTENTS

CAUTIONS	3
SOFTWARE LICENSE	4
ENVIRONMENTAL INFORMATION	5
INTRODUCTION	6
MAIN FEATURES	7

1 PREPARATIONS

PART NAMES	9
CONNECTING THE POWER CORD	12
POWER ON AND OFF	12

2 LOADING PAPER

PAPER	14
LOADING THE PAPER TRAY	15
BYPASS FEED (including special paper)	17
CHANGING A TRAY'S PAPER SIZE SETTING	19

3 MAKING COPIES

NORMAL COPYING	20
SELECTING THE TRAY	23
MAKING A COPY DARKER OR LIGHTER	24
REDUCTION/ENLARGEMENT/ZOOM	25

4 CONVENIENT COPY FUNCTIONS

AUTOMATIC TWO-SIDED COPYING	26
SORT COPY	29
COPYING MULTIPLE ORIGINALS ONTO A SINGLE SHEET OF PAPER (2 IN 1 copy)	31
CREATING MARGINS WHEN COPYING (Margin shift)	34

5 INSTALLING THE SOFTWARE

SOFTWARE	36
BEFORE INSTALLATION	37
INSTALLING THE SOFTWARE	38
SETTING UP BUTTON MANAGER	45

6 PRINTER/SCANNER FUNCTIONS

USING THE PRINTER MODE	50
BASIC PROCEDURE FOR PRINTING	50
USING THE SCANNER MODE.....	51
SCANNING USING THE KEYS ON THE MACHINE	51
SCANNING FROM YOUR COMPUTER	52
OPERATION IN COPY, PRINTER, AND SCANNER MODES	52
HOW TO USE THE ONLINE MANUAL	53

7 USER SETTINGS

USER PROGRAMS.....	54
SELECTING A SETTING FOR A USER PROGRAM.....	59

8 TROUBLESHOOTING AND MAINTENANCE

DISPLAY MESSAGES.....	61
TROUBLESHOOTING THE MACHINE	63
PROBLEMS DURING SETUP OF THE SOFTWARE	67
MISFEED REMOVAL	70
TONER CARTRIDGE REPLACEMENT	74
SCAN HEAD LOCKING SWITCH	76
CHECKING THE TOTAL COUNT.....	77
MAINTENANCE REQUIRED	77
CLEANING THE MACHINE	78

9 OPTIONAL EQUIPMENT



SYSTEM CONFIGURATION	80
FACSIMILE EXPANSION KIT (AR-FX13).....	80
NETWORK EXPANSION KIT (AR-NB2 A)	80
REVERSING SINGLE PASS FEEDER (AR-RP9).....	80
250-SHEET PAPER FEED UNIT (AR-D33)	80

10 APPENDIX

SPECIFICATIONS	82
INDEX.....	87

CAUTIONS

Caution label on the machine

The label ( ) in the fusing area of the machine indicates the following:

 : Caution, risk of danger

 : Caution, hot surface

Cautions on using the machine

Follow the cautions below when using this machine.

Warning:

- The fusing area is hot. Exercise care in this area when removing misfed paper.
- Do not look directly at the light source. Doing so may damage your eyes.

Caution:

- Place the machine on a firm, level surface.
- Do not install the machine in a humid or dusty location.
- When the machine is not used for a long time, for example during prolonged holidays, turn the power switch off and remove the power cord from the outlet.
- When moving the machine, be sure to turn the power switch off and remove the power cord from the outlet.
- Do not switch the machine rapidly on and off. After turning the machine off, wait 10 to 15 seconds before turning it back on.
- Do not cover the machine with a dust cover, cloth or plastic film while the power is on. Doing so may prevent heat radiation, damaging the machine.
- Use of controls or adjustments or performance of procedures other than those specified herein may result in hazardous radiation exposure.
- The socket-outlet shall be installed near the machine and shall be easily accessible.

Important points when selecting an installation site

Do not install your machine in areas that are:

- damp, humid, or very dusty
- exposed to direct sunlight
- poorly ventilated
- subject to extreme temperature or humidity changes, e.g., near an air conditioner or heater.

Be sure to allow the required space around the machine for servicing and proper ventilation.

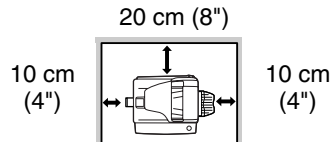

Cautions on handling the machine

Be careful in handling the machine as follows to maintain the performance of this machine.

Do not drop the machine, subject it to shock or strike it against any object.

Store spare toner cartridges in a cool dry place without removing from the package before use.

- If they are exposed to direct sunlight or excessive heat, poor copies may result.

Do not touch the photoconductive drum (green portion).

- Scratches or smudges on the drum will cause dirty copies.

Trademark acknowledgements

- Microsoft®, Windows®, Windows® 98, Windows® Me, Windows® 2000, Windows® XP, Windows Vista® and Internet Explorer® are registered trademarks or trademarks of Microsoft Corporation in the U.S.A. and other countries.
- Macintosh is a trademark of Apple Inc., registered in the U.S. and other countries.
- IBM, PC/AT, and PowerPC are trademarks of International Business Machines Corporation.
- Adobe, the Adobe logo, Acrobat, the Adobe PDF logo, and Reader are registered trademarks or trademarks of Adobe Systems Incorporated in the United States and other countries.
- All other trademarks and copyrights are the property of their respective owners.

SOFTWARE LICENSE

The SOFTWARE LICENSE will appear when you install the software from the CD-ROM. By using all or any portion of the software on the CD-ROM or in the machine, you are agreeing to be bound by the terms of the SOFTWARE LICENSE.

ENVIRONMENTAL INFORMATION



Products that have earned the ENERGY STAR® are designed to protect the environment through superior energy efficiency.

The products that meet the ENERGY STAR® guidelines carry the logo shown above. The products without the logo may not meet the ENERGY STAR® guidelines.

A small amount of ozone is produced within the unit during operation. The emission level is insufficient to cause any health hazard.

Note:

The present recommended long term exposure limit for ozone is 0.1ppm (0.2mg/m³) calculated as an 8 hr. time-weighted average concentration.

However, since the small amount that is emitted may have an objectionable odor, it is advisable to place the unit in a ventilated area.

INTRODUCTION



Some model may not be available in some countries.

Using the manual

This machine has been designed to provide convenient copying features in a minimum amount of office space and with maximum operational ease. To get full use of all machine features, be sure to familiarize yourself with this manual and the machine. For quick reference during machine use, keep this manual in a handy location.

About the operation manuals

The operation manuals for the machine are as follows:

Operation Manual (this manual)

Explains the machine and how to use it as a copier. Also explains how to install the software that allows the machine to be used as a printer and scanner for your computer.

Online Manual (on the accessory CD-ROM)

This manual explains the procedures for using the machine as a printer or a scanner.

Conventions used in this manual and online manual

- The explanations in this manual assume that a reversing single pass feeder is installed on the machine.
For some functions and procedures, the explanations assume that devices other than the above are installed.
- Where "AR-XXXX" appears in this manual, please substitute the name of your model for "XXXX". For the name of your model, see the operation panel on the machine.
- Illustrations of driver screens and other computer screens show the screens that appear in Windows XP Home Edition. Some of the names that appear in these illustrations may differ slightly from the screens that appear in other operating systems.
- The explanations in this manual assume that the person who will install the product and the users of the product have a working knowledge of Microsoft Windows.
- This operation manual refers to the Reversing Single Pass Feeder as the "RSPF".
- In this manual, the following icons are used to provide the user with information pertinent to the use of the machine.



Warning Warns that injury may result if the contents of the warning are not properly followed.



Caution Cautions that damage to the machine or one of its components may result if the contents of the caution are not properly followed.



Note Notes provide useful information on the specifications, functions, performance, and operation of the machine.

The display screens, messages, and key names shown in the manual may differ from those on the actual machine due to product improvements and modifications.

MAIN FEATURES

High-speed laser copying

First-copy time*¹ is only 8.0*² seconds.

Copying speed is 20 copies per minute. This is ideal for business use and provides a big boost to workplace productivity.

*¹ The first-copy time is measured after the power save indicator turns off following power on, using the document glass with the polygon rotating in the copy ready state and "LSU SETTING" set to ON in the user programs (A4 (8-1/2" x 11"), paper fed from paper tray).

*² When user program 24 is set to OFF.

High-quality digital image

- High-quality copying at 600 dpi is performed.
- In addition to automatic exposure adjustment, two original modes can be selected: "TEXT" for text-only originals, and "PHOTO" for photographs. The exposure can be adjusted to five levels in each mode.
- The photo mode copying function allows clear copying of delicate halftone original images such as monochrome photos and colour photos.

Enhanced copying features

- Zoom copies can be made from 25% to 400% in increments of 1%. (When the RSPF is being used, the zoom copy ratio range is 50% to 200%.)
- Continuous copying of up to 99 copies is possible.
- Sets of output can be offset from each other for easy separation (offset function).
- Sorting by sets is possible without the need for a sorter or other special device (Sort copy).
- Includes convenient features such as margin shift, 2 IN 1 copy, and automatic two-sided copying.

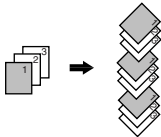

Sort copy

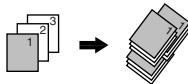

Offset function

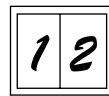

2 IN 1 copy

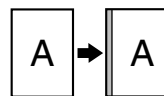

Margin shift

Scan once/Print many

- The machine is equipped with a memory buffer allowing the machine to scan an original once and make up to 99 copies of the scanned image. This improves workflow, reduces operating noise from the machine and reduces wear and tear on the scanning mechanism, which provides for a higher reliability.

LCD panel displays messages

- The LCD panel displays messages that show function settings and the status of the machine.

Laser printer function

- The accompanying printer driver can be installed to enable use of the machine as a printer.

Colour scanner function

- The accompanying scanner driver can be installed and the machine connected to a computer using a USB cable to enable use as a scanner.

Fax function (option)

- The optional Facsimile Expansion Kit can be installed to enable the machine to be used as a fax machine. (Facsimile Expansion Kit Operation Manual)

Network connection (option)

- The optional Network Expansion Kit can be installed to enable the machine to be used as a network printer and network scanner. (Network Expansion Kit Operation Manual)

Environment and people friendly design

- Preheat mode and auto power shut-off mode are provided to reduce power consumption when the machine is not in use.
- A universal design has been implemented in the product whereby the height of the operation panel and shape of the keys are designed to be usable by as many people as possible.

This chapter provides basic information that you should know before using the machine.

PART NAMES

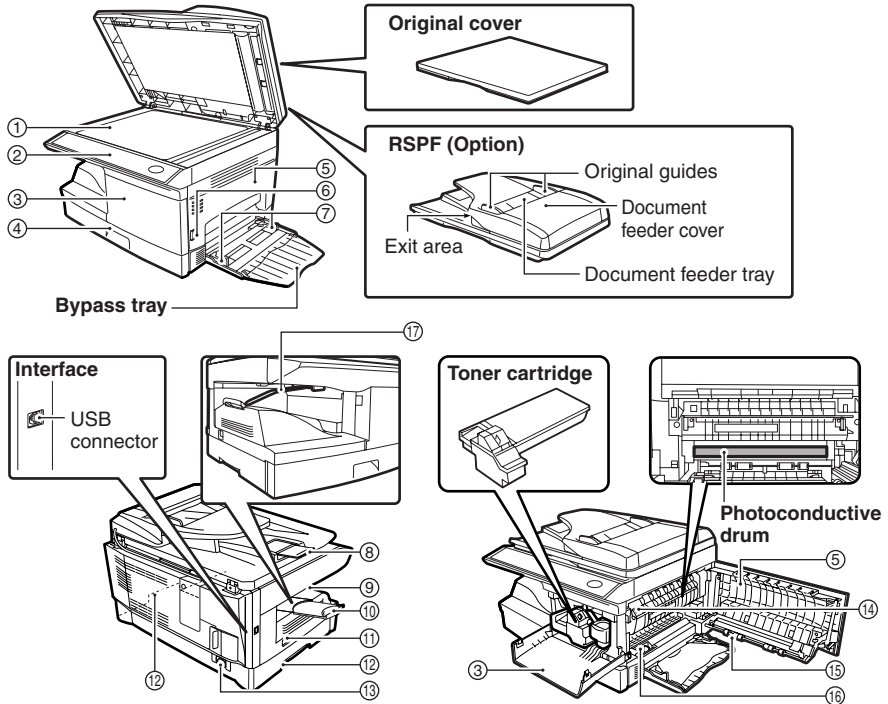

- | | |
|----------------------------------|-------------------------------|
| ① Document glass | ⑩ Paper output tray extension |
| ② Operation panel | ⑪ Power switch |
| ③ Front cover | ⑫ Handles |
| ④ Paper tray | ⑬ Power cord socket |
| ⑤ Side cover | ⑭ Fusing unit release lever |
| ⑥ Side cover open button | ⑮ Transfer charger |
| ⑦ Bypass tray paper guides | ⑯ Charger cleaner |
| ⑧ Original output tray extension | ⑰ Paper holder arm |
| ⑨ Paper output tray | |

Operation panel

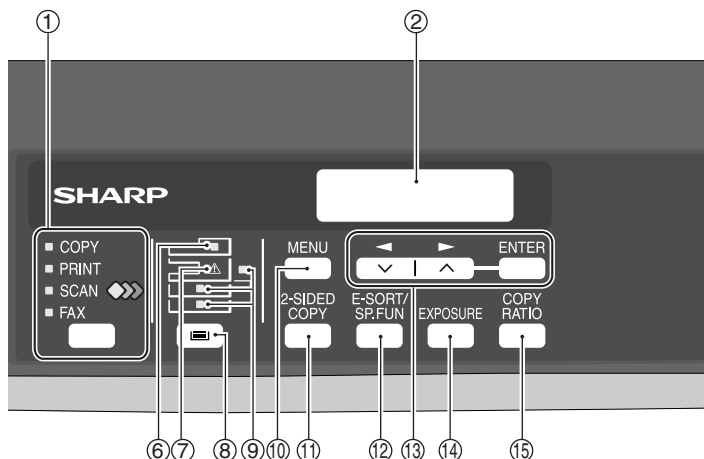

- ① **[MODE SELECT] key / Mode indicators**
 Press this key to select the mode. The indicator of the selected mode lights (copy, printer, scanner, fax mode indicators).
- ② **Display**
 This shows messages indicating the machine status and any problems that occur, as well as user programs and function setting menus.
- ③ **Numeric keys**
 Use these to enter the number of copies and other numerical settings. The keys can also be used to select items in function setting menus.
- ④ **[CLEAR] key (C)**
 Use this to clear the set number of copies, as well as cancel a job that is in progress. When a setting menu appears, use this key to move back to the previous menu level.
- ⑤ **Power save indicator**
 This lights up when the power save function is activated.
- ⑥ **RSPF indicator***
 This lights up when an original is placed in the RSPF.
- ⑦ **Error indicator**
 This lights steadily or blinks when a paper misfeed or other error occurs.
- ⑧ **[TRAY SELECT] key (tray icon)**
 Use to select the paper tray that has the desired paper for copying.
- ⑨ **Tray location indicator**
 Indicates the selected paper tray. The indicator blinks when the tray is out of paper during operation or is not closed properly.
- ⑩ **[MENU] key**
 Press this key to select the paper size for copying, to configure a user program or to display the total count.
- ⑪ **[2-SIDED COPY] key**
 Press in copy mode to select one-sided or two-sided settings for the original and for the output.
- ⑫ **[E-SORT/SP.FUN] key**
 Press to select the sort function, 2 IN 1 copy function, or margin shift function.
- ⑬ **[◀] key (◀), [▶] key (▶), [ENTER] key**
 Press the [◀] key (◀) or [▶] key (▶) to select an item in a function setting menu. Press the [ENTER] key to enter a selection.
- ⑭ **[EXPOSURE] key**
 Use to switch from auto exposure adjustment to text mode or photo mode.

* Only operates when an RSPF is installed.

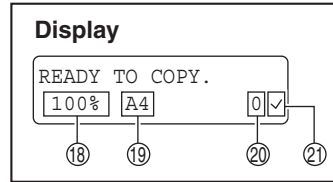
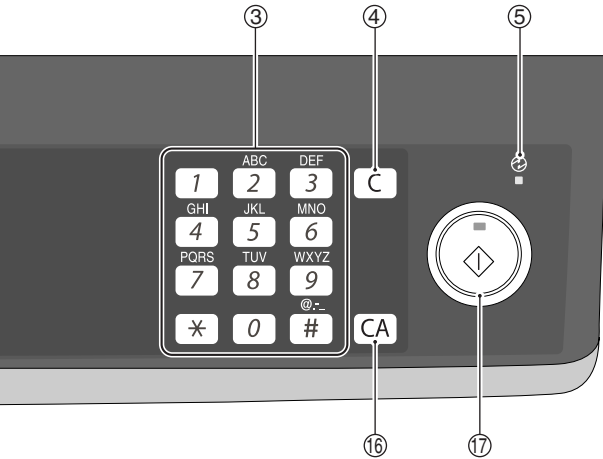

15 [COPY RATIO] key

Press to select an enlargement or reduction ratio.

To select a preset ratio setting, press the [COPY RATIO] key and select the desired preset ratio. To select a ratio that is not preset, press the [COPY RATIO] key, select the preset ratio that is closest to the desired ratio, and then press the [◀] key (◁) or [▶] key (▷) to increase or decrease the ratio in increments of 1%.

16 [CLEAR ALL] key (CA)

This returns all functions to the default settings. When pressed in a setting menu, this returns the settings and display to the initial state.

17 [START] key (⏻) / Ready indicator

The ready indicator lights up when copying or scanning is possible.

To begin copying, press the [START] key (⏻).

The [START] key (⏻) is also pressed to return to normal operation from auto power shut-off mode.

18 Shows the current copy ratio.

19 Shows the selected paper size.

20 Shows the number of copies that has been entered with the numeric keys.

21 A checkmark "✓" appears when the exposure has been changed, or when two-sided copying, sort, 2 IN 1, or margin shift is selected.

CONNECTING THE POWER CORD



If you use the unit in a country other than the country where the unit was purchased, you will need to make sure that your local power supply is compatible with your model. If you plug the unit into an incompatible power supply, irreparable damage to the unit will result.

- 1 Ensure that the power switch of the unit is in the OFF position. Insert the attached power cord into the power cord socket at the rear of the unit.

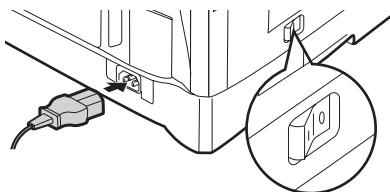

- 2 Plug the other end of the power cord into the nearest outlet.



- Only insert the power cord into a properly grounded wall socket.
- Do not use extension cords or power strips.

POWER ON AND OFF

The power switch is located on the left side of the machine.

Power on

Turn the power switch to the "ON" position.

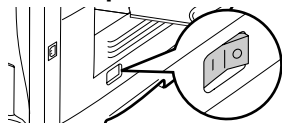

The ready indicator will light up and other indicators which show the initial settings of the display will also light up to indicate the ready condition. For the initial settings, see "Initial settings" (below).

You can select copy settings and press the [START] key (⊙) after the power switch is turned on. Copying will start automatically.

Language setting

The first time the power is turned on after shipment from the factory, a message will appear in English in the display prompting you to select the language. Select the language with the [◀] key (◀) or [▶] key (▶) and then press the [ENTER] key. The language can also be changed in the user programs (p.57).

Initial settings

The machine reverts to the initial settings when it is first turned on, when the [CLEAR ALL] key (CA) is pressed, or when no keys are pressed for the preset "AUTO CLEAR" time following the end of a copy job. When the machine reverts to the initial settings, all settings and functions selected to that point are cancelled. The "AUTO CLEAR" can be changed in the user programs. (p.54)

When in the copy mode



The main screen of copy mode appears.

Copy ratio: 100%, Exposure: Automatic
Copy quantity: 0, All special copier modes: Off

Scanning unit (scan head)

When the machine is able to copy or scan (the ready indicator is on), the scanning unit is lit.

Power off

Make sure that the machine is not in operation and then turn the power switch to the "OFF" position.

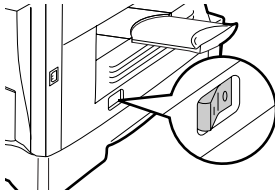

If the power switch is turned off while the machine is in operation, a misfeed may occur and the job that was in progress will be cancelled.

In cases where the machine will not be used for a long time, turn off the power switch and remove the power cord from the outlet.

Check the following to make sure the machine is not in operation:

- The ready indicator is lit. (Initial state)
- The power save indicator is lit. (preheat mode or auto power shut-off mode)

Power save modes

The machine has two power save modes to reduce overall power consumption and thereby reduce the cost of operation. In addition, these modes conserve natural resources and help reduce environmental pollution. The two power save modes are preheat mode and auto power shut-off mode.

Preheat mode

This function automatically switches the machine to a low power consumption state if the set duration of time elapses without the machine being used when the power is on. In this mode, the power save indicator lights up. Normal operation automatically resumes when a key on the operation panel is pressed, an original is placed, a print job is received.

Auto power shut-off mode

This function automatically switches the machine to a state that consumes even less power than preheat mode if the set duration of time elapses without the machine being used when the power is on. The power save indicator lights up, the display shows a message indicating that the machine is in auto power shut-off mode. To resume normal operation, press the [START] key (⊙). Normal operation also resumes automatically when a print job is received or scanning is begun from a computer. While in auto power shut-off mode, no keys (except the [START] key (⊙)) can be used.



The preheat activation time and the auto power shut-off time can be changed with "PREHEAT MODE" and "AUTO SHUT-OFF TIME" in the user programs. It is suggested that you set times that are appropriate for your usage of the machine. (p.54 and p.55)

Check original cover/RSPF open function

When enabled, this function may help prevent wasteful use of toner that occurs when the original cover/RSPF cover is not completely closed.

If the start (⊙) key is pressed when the original cover/RSPF cover is not completely closed, "CHECK ORIGINAL" will appear in the display and copying may not take place. If copying does not take place, copying can be performed by pressing the start (⊙) key again, however, the scan size set in "CHANGING A TRAY'S PAPER SIZE SETTING" (p.19) or "VALID COPY WIDTH" (program number 25) (p.57) will be used. If the original cover/RSPF cover is completely closed after "CHECK ORIGINAL" appears, copying will take place at the normal size.

The tray location indicator will blink when there is no paper in the selected paper tray, or when the selected paper tray is not closed or is improperly closed.

PAPER

For best results, use only SHARP recommended paper.

Paper tray type	Paper type	Size	Weight	Capacity
Paper tray	Standard paper Recycled paper	A4 (210 mm x 297 mm) A5 (148 mm x 210 mm) B5 (182 mm x 257 mm) 5-1/2" x 8-1/2" (Invoice) 8-1/2" x 11" (Letter) 8-1/2" x 13" (Foolscap) 8-1/2" x 14" (Legal)	56 g/m ² to 80 g/m ² (15 lbs. to 21 lbs.)	250 sheets * ¹ (The paper should not exceed the line on the tray)
Bypass tray	Standard paper Recycled paper	89 mm x 140 mm to 216 mm x 356 mm (3-1/2" x 5-1/2" to 8-1/2" x 14")	56 g/m ² to 80 g/m ² (15 lbs. to 21 lbs.)	50 sheets * ¹
	Thick paper		56 g/m ² to 128 g/m ² (15 lbs. to 34.5 lbs.)* ³	
	Transparency film/Labels			
	Envelopes * ²	International DL (110 mm x 220 mm) International C5 (162 mm x 229 mm) Monarch (3-7/8" x 7-1/2") Commercial 9 (3-7/8" x 8-7/8") Commercial 10 (4-1/8" x 9-1/2")		Load one sheet at a time in the bypass tray.

*¹ The number of sheets of paper that can be loaded varies depending on the weight of the paper.

*² Do not use non-standard envelopes or envelopes that have metal clasps, plastic snappers, strings, windows, linings, self-adhesive strips, patches or synthetic materials. Do not use envelopes that are filled with air or envelopes that have labels or stamps attached. These will damage the machine.

*³ When using paper heavier than 104 g/m² (28 lbs.), use paper that is A4 (8-1/2" x 11") or smaller.

Special papers

Follow these guidelines when using special papers.

- Use SHARP recommended transparency film and label sheets. Using other than SHARP recommended paper may result in misfeeds or smudges on the output. If other than SHARP recommended media must be used, feed each sheet one at a time using the bypass tray (do not attempt continuous copying or printing).
- There are many varieties of special paper available on the market, and some cannot be used with this machine. Before using special paper, contact your authorised service representative.
- Before using other than SHARP recommended paper, make a test copy to see if the paper is suitable.

LOADING THE PAPER TRAY



Make sure that the paper is not torn, is free of dust, and has no wrinkles or curled edges.

- 1** Raise the handle of the paper tray and pull the paper tray out until it stops.

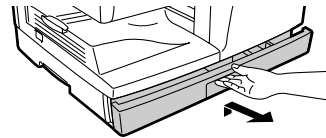

- 2** Fan the paper and insert it into the tray. Make sure that the edges go under the corner hooks.



- Do not load paper above the maximum height line (). Exceeding the line will cause a paper misfeed.
- If the paper is not fanned, double-feeds or misfeeds may occur.
- Make sure the stack of paper is straight before loading it. When adding paper, take the remaining paper out and combine it into a single stack with the new paper.
- Make sure that all the paper in the stack is the same size and type.
- When loading paper, ensure that there is no space between the paper and the guide, and make sure that the guide is not set too narrow and causes the paper to bend. Incorrect loading will cause the paper to skew or misfeed.

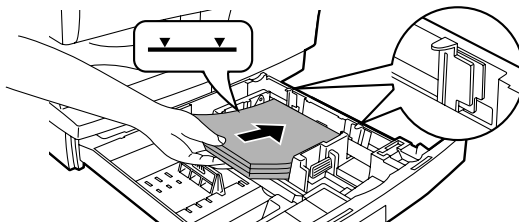

3 Gently push the paper tray back into the machine.



- If you loaded a paper size that is different from the previously loaded paper size, change the paper size setting as explained in "CHANGING A TRAY'S PAPER SIZE SETTING" (p.19)
- When not using the machine for an extended period, remove all paper from the paper tray and store it in a dry place. If paper is left in the machine for an extended period, the paper will absorb moisture from the air, resulting in paper jams.

BYPASS FEED (including special paper)

The bypass tray can be used to feed standard paper, transparency film, labels, envelopes, and other special purpose paper.

Important points when inserting paper in the bypass tray

Up to 50 sheets of standard copy paper can be inserted in the bypass tray. (Capacity will vary depending on the type of paper loaded.)

Be sure to place envelopes horizontally as shown in the following diagram.

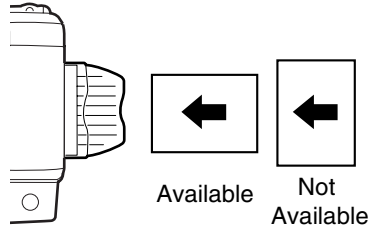

- When loading envelopes, make sure that they are straight and flat and do not have loosely glued construction flaps (not the closure flap).
- Special papers such as SHARP recommended transparency film, labels, and envelopes must be fed one sheet at a time through the bypass tray.
- When adding paper, first remove any paper remaining in the tray, combine it with the paper to be added and then reload as a single stack. The paper to be added must be the same size and type as the paper already in the tray.
- Do not use paper that is smaller than the original. This may cause smudges or unclear images.
- Do not use paper that has already been printed on by a laser printer or plain paper fax machine. This may cause smudges or unclear images.

Envelopes

Do not use the following envelopes, as misfeeds will occur.

- Envelopes with metal tabs, clasps, strings, holes, or windows.
- Envelopes with rough fibers, carbon paper, or glossy surfaces.
- Envelopes with two or more flaps.
- Envelopes with tape, film, or paper attached to the flap.
- Envelopes with a fold in the flap.
- Envelopes with glue on the flap to be moistened for sealing.
- Envelopes with labels or stamps.
- Envelopes that are slightly inflated with air.
- Envelopes with glue protruding from the seal area.
- Envelopes with part of the seal area peeled off.
- Be sure to select com9, com10, DL, C5 or Monarch in the paper size setting of the printer driver. (For detailed information on the printer driver, refer to the online manual.)

Loading paper in the bypass tray



- Paper must be fed narrow side first into the feed slot.
- Special papers such as transparency film, labels, and envelopes must be fed one sheet at a time through the bypass tray.
- When copying onto transparency film, remove each copy promptly. Do not let copies stack up.

1 Open the bypass tray and extend the tray.

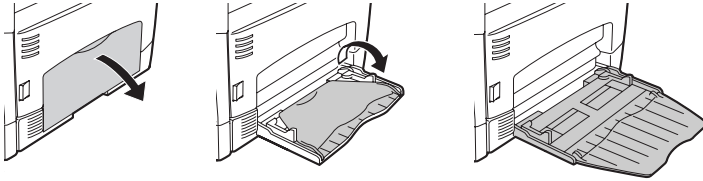

To close the bypass tray, perform step ① and then step ② in the illustration and push the round projections at the right of the tray until they click.

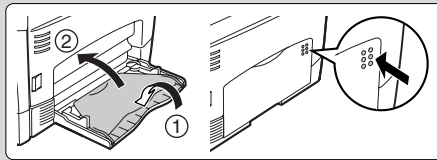

2 Set the bypass tray paper guides to the paper width. Insert the paper (print face down) all the way into the bypass tray.

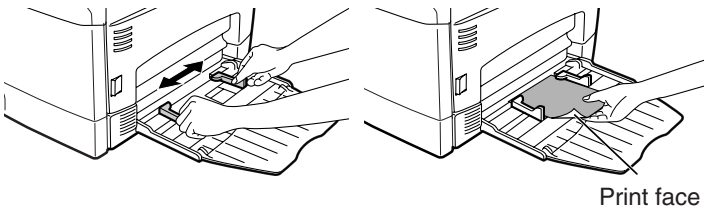

3 Press the [TRAY SELECT] key () to select the bypass tray.

Note for loading thick paper

Confirm that user program 29 is set to "2 (HEAVY PAPER)" when using thick paper. (See page 57.)

CHANGING A TRAY'S PAPER SIZE SETTING

Follow these steps to change a tray's paper size setting.



- The paper size setting cannot be changed when the machine has stopped temporarily due to running out of paper or a misfeed.
- During printing (even in copy mode), the paper size setting cannot be changed.

1 Press the [MENU] key.
Press the [◀] key (▼) or [▶] key (▲) until "PAPER SIZE" appears, and then press the [ENTER] key.

2 Press the [◀] key (▼) or [▶] key (▲) to select the tray, and then press the [ENTER] key.

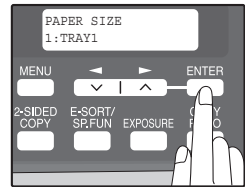

3 Press the [◀] key (▼) or [▶] key (▲) to select the paper size, and then press the [ENTER] key.

The paper size changes as follows each time the [◀] key (▼) or [▶] key (▲) is pressed:
"A4" → "B5" → "A5" → "8.5x14" → "8.5x13"
→ "8.5x11" → "5.5x8.5".

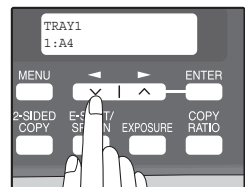

When you have finished configuring the tray's paper size setting, press the [MENU] key.

4 Squeeze the lock lever of the front guide and slide the front guide to match the width of the paper, and move the left guide to the appropriate slot as marked on the tray.

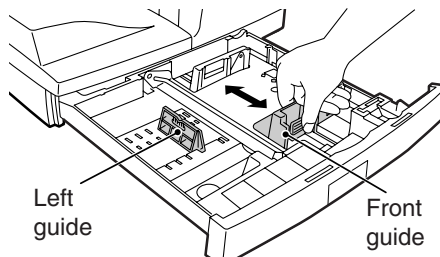

- The front guide is a slide-type guide. Grasp the locking knob on the guide and slide the guide to the indicator line of the paper to be loaded.
- The left guide is an insert-type guide. Remove it and then insert it at the indicator line of the paper to be loaded.

This chapter explains basic copying functions.

NORMAL COPYING

Using the document glass



- The document glass can scan up to 216 mm x 356 mm (8-1/2" x 14") original.
- When a copy is made, the edges will not be copied (image loss). For the image loss, see the "SPECIFICATIONS" (p.82).

- 1 Open the original cover/RSPF, and place the original face down on the document glass.**

[How to place the original]

Align the original with the original scale and the centring (▶) mark.

Original scale

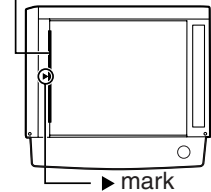

- 2 Gently close the original cover/RSPF.**

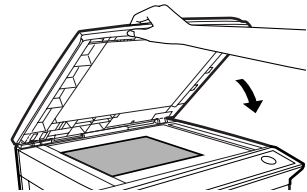

- 3 Select the number of copies and any other copy settings, and then press the [START] key (⊙).**



- To stop copying in the middle of a run, press the [CLEAR] key (□).
- For the copy settings, see pages 23 through 35.

Copying books or originals with folds or creases

Press down on the original cover/RSPF while copying as shown. If the original cover/RSPF is not completely closed, shadows may appear on the copy or it may be fuzzy. Straighten originals that have folds or creases before placing it on the document glass.

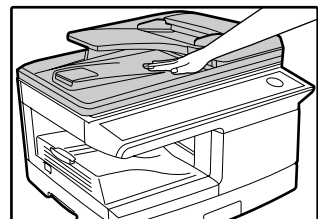

Setting a large original

The original cover can be removed to allow copying of bulky objects.

- 1 Simply lift the original cover straight up.

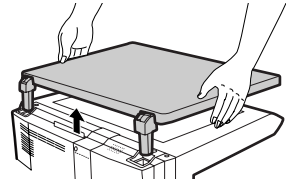

- 2 To reattach the original cover, reverse the above procedure.

Using the RSPF (Option)



- Originals that are 140 mm x 216 mm to 216 mm x 356 mm (5-1/2" x 8-1/2" to 8-1/2" x 14") and 56 g/m² to 90 g/m² (14 lbs. to 24 lbs.) can be used. A maximum of 50 pages can be placed at once.
- Straighten curled originals before placing them in the document feeder tray. Curled originals may cause misfeeds.
- Place originals horizontally.
- Before placing originals in the document feeder tray, be sure to remove any staples or paper clips from them.
- When a copy is made, the edges will not be copied (image loss). For the image loss, see the "SPECIFICATIONS" (p.82).
- When using the margin shift function, check the position of the margins carefully. (p.34)

3

- 1 Make sure that an original has not been left on the document glass.

- 2 Adjust the original guides to the size of the originals.

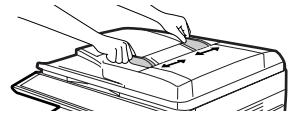

- 3 Place the original(s) face up in the document feeder tray without trying to force them in.

The RSPF indicator on the operation panel will light up. If this indicator does not light up, the originals are not properly set or the RSPF is not properly closed.

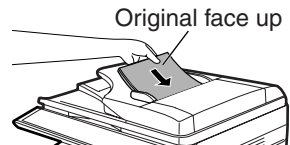

- 4 Select the number of copies and any other copy settings, and then press the [START] key (⏻).



- The default output mode for copying from the RSPF is sort mode (P.29), and a checkmark "✓" will automatically appear in the display (P.11). If "SORT AUTO SELECT" is disabled in the user programs, the default output mode will be non-sort mode. (P.57)
- To stop copying in the middle of a run, press the [CLEAR] key (⏻).
- For the copy settings, see pages 23 through 35.

MAKING COPIES

Originals that cannot be used in the RSPF

The following originals cannot be used. These may cause misfeeds or smudging and unclear images.

- Transparencies, tracing paper, other transparent or translucent paper, and photographs.
- Carbon paper, thermal paper.
- Originals that are creased, folded, or torn.
- Glued originals, cut-out originals.
- Originals with binder holes.
- Originals printed using an ink ribbon (thermal transfer printing), originals on thermal transfer paper.

Original output tray extension

When placing an original larger than A4 (8-1/2" x 11") size, pull out the original output tray extension of the RSPF.

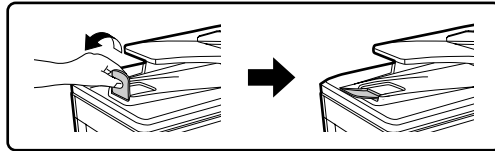

Capacity of paper output tray

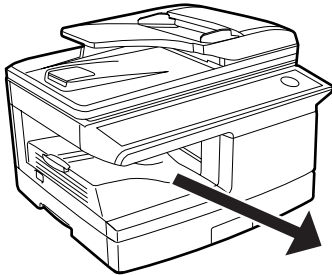

The paper output tray can hold a maximum of 200 pages. If more than 200 pages are allowed to accumulate, a paper jam may occur.

Paper output tray extension

When copying onto paper larger than A4 (8-1/2" x 11") size, pull out the paper output tray extension.

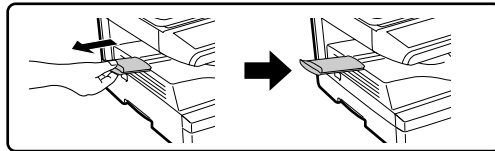

Paper holder arm

The paper output tray has a paper holder arm. The paper holder arm presses gently on the output paper to stack it (p.9).



After removing paper, if you need to return the paper to the paper output tray, lift up the paper holder arm and place the paper under the arm.

Setting the number of copies

Press the numeric keys to set the number of copies.

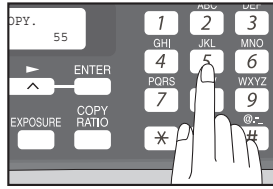

- The set number of copies appears in the display. A maximum of 99 copies can be set.
- If you wish to make only a single copy, copying is possible with the display showing "0".



If you enter the wrong number, press the [CLEAR] key (C) and enter the correct number.

SELECTING THE TRAY

Press the [TRAY SELECT] key (T).

Each time, you press the [TRAY SELECT] key (T), the location indicated by the tray location indicator changes in the following order : paper tray → lower paper tray (when the 250-sheet paper feed unit is installed.) → bypass tray.

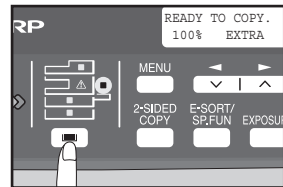

The tray location indicator will blink when there is no paper in the paper tray during operations, or when the tray is not closed or is improperly closed.

MAKING A COPY DARKER OR LIGHTER

Automatic exposure adjustment is initially enabled. This function automatically adjusts the copy image according to the original being copied. If you wish to select the exposure level yourself, follow the steps below. (Select from 2 original types and 5 exposure levels for each original type.) The exposure level used in automatic exposure adjustment can also be changed with "AE LEVEL ADJUST" in the user programs (p.57).

Original types

- AUTO Automatic exposure adjustment is enabled and the exposure is automatically adjusted according to the original being copied. The exposure is lowered for coloured areas and background shadows.
- TEXT The exposure is raised for light areas and lowered for dark backgrounds to make text easier to read.
- PHOTO ... Halftones in the photo are reproduced with greater clarity.

1 Place the original(s).

2 Press the [EXPOSURE] key to select the original type.

The original image type changes as follows each time the [EXPOSURE] key is pressed: "AUTO" → "TEXT" → "PHOTO".

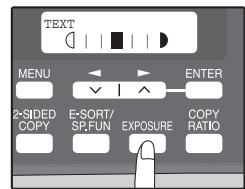

To return to auto exposure adjustment, press the [EXPOSURE] key until "AUTO" appears.

3 If needed, adjust the exposure level for TEXT or PHOTO.

For a darker image, press the [▶] key (◀▶). For a lighter image, press the [◀] key (▶◀).

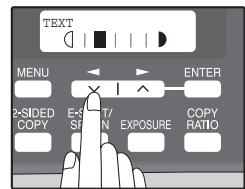

4 Press the [ENTER] key.

5 Select the number of copies and any other copy settings, and then press the [START] key (⊙).



Exposure value guidelines (When in "TEXT" setting)

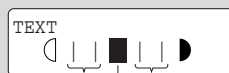

- Coloured text or text written in pencil
- Normal originals
- Dark originals like newspapers

REDUCTION/ENLARGEMENT/ZOOM

Copies can be reduced down to 25% or enlarged up to 400%. (When the RSPF is being used, the zoom copy ratio range is 50% to 200%.) The [COPY RATIO] key can be pressed to quickly select a ratio from among eight preset ratios. In addition, the [◀] key (▽) and [▶] key (△) can be pressed to select the ratio in increments of 1%.

1 Place the original(s) and check the paper size.

2 Press the [COPY RATIO] key.

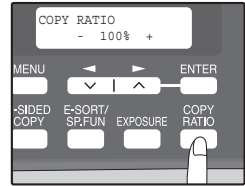

3 Press the [COPY RATIO] key and/or [◀] key (▽) or [▶] key (△) to select the desired copy ratio and then press the [ENTER] key.

Selecting a preset ratio

The preset ratios change as follows each time the [COPY RATIO] key is pressed:

"100%" → "86%" → "70%" → "50%" → "25%" →
"400%" → "200%" → "141%"
("100%" → "78%" → "64%" → "50%" → "25%" →
"400%" → "200%" → "129%")

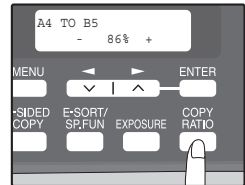

Fine adjustment of the ratio

The ratio can be adjusted from 25% to 400% in increments of 1%.

Use the [◀] key (▽) or the [▶] key (△) for fine adjustment.

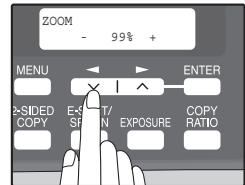



- To return the ratio to 100%, press the [COPY RATIO] key until 100% appears.
- Press the [COPY RATIO] key to set the approximate ratio, then press the [◀] key (▽) or [▶] key (△).
- To decrease or increase the zoom ratio rapidly, hold down the [◀] key (▽) or [▶] key (△).
The ratio will stop changing at each of the preset ratios. To continue changing the ratio, release the key and then hold it down again.

4 Select the number of copies and any other copy settings, and then press the [START] key (⊙).

The copy will be delivered to the paper output tray.

AUTOMATIC TWO-SIDED COPYING

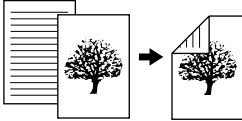
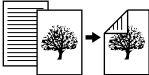
Two originals can be automatically copied onto both sides of a single sheet of paper. When the RSPF is used, two-sided copies of two-sided originals can easily be made.

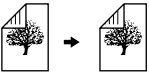
	Original → Paper			Usable paper
Document glass	One-sided original → Two sides 			A4, A5, B5, 5-1/2" x 8-1/2", 8-1/2" x 11", 8-1/2" x 13", 8-1/2" x 14" • The bypass tray cannot be used.
RSPF	One-sided original → Two sides 	Two-sided original → One side 	Two-sided original → Two sides 	A4, A5, B5, 5-1/2" x 8-1/2", 8-1/2" x 11", 8-1/2" x 13", 8-1/2" x 14" • Special paper cannot be used. • The bypass tray can only be used when making one-sided copies from two-sided originals.

When performing automatic two-sided copying of one-sided originals, the orientation of the copied image can be selected according to the binding position of the paper.

SHORT EDGE: Select when binding the paper at the short edge.



(Paper orientation: Landscape) (Paper orientation: Portrait)

LONG EDGE: Select when binding the paper at the long edge.



(Paper orientation: Landscape) (Paper orientation: Portrait)

Using the document glass

1 Place the original that you wish to copy onto the front side of the paper on the document glass and close the original cover/RSPF.

2 Press the [2-SIDED COPY] key until "1 TO 2" appears, and then press the [ENTER] key.

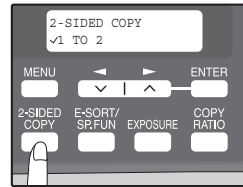

3 Press the [◀] key (◁) or [▶] key (▷) to select the binding edge and then press the [ENTER] key.

Select "LONG EDGE" or "SHORT EDGE". The "LONG EDGE" and "SHORT EDGE" are shown in the illustration on the preceding page.

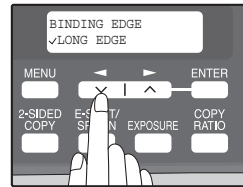

4 Select the number of copies and any other settings, and then press the [START] key (⊙).

"[START] : NEXT SCAN [#] : START PRINT" appears and the original is scanned into memory.

To immediately print the scanned image, press the [#] key.

5 Replace the original with the next original and close the original cover/RSPF, and then press the [START] key (⊙).

Repeat step 5 until all originals have been scanned.

Copies will be output each time two originals have been scanned.

When the number of original pages is odd and "[START] : NEXT SCAN [#] : START PRINT" appears, press the [#] key after all pages have been scanned.

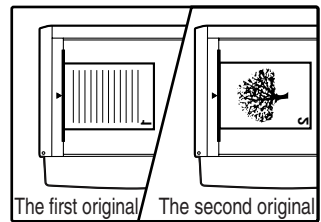

- If you need to clear the data scanned into memory, press the [CLEAR] key (C). When the [CLEAR] key (C) is pressed, the number of copies setting is also cleared.
- To cancel automatic two-sided copying, press the [CLEAR ALL] key (CA) or press the [2-SIDED COPY] key, select the "1 TO 1", and then press the [ENTER] key.
- If the special function sort mode was selected in step 4, copying will not begin until the [#] key is pressed.

Using the RSPF (Option)

1 Place the original(s) in the RSPF. (p.21)

If you place an odd number of originals for one-sided to two-sided copying, the last page will be one-sided.

2 Press the [2-SIDED COPY] key and select the two-sided copy mode that you wish to use.

The mode changes as follows each time you press the [2-SIDED COPY] key:

"1 TO 1" → "1 TO 2" → "2 TO 2" → "2 TO 1"

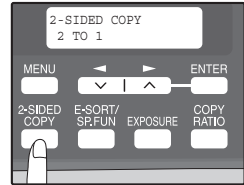

- "1 TO 2": Two-sided copies from one-sided originals
- "2 TO 2": Two-sided copies from two-sided originals
- "2 TO 1": One-sided copies from two-sided originals

3 Press the [ENTER] key.

If you selected "1 TO 2" in step 2, select "LONG EDGE" or "SHORT EDGE" and press the [ENTER] key. LONG EDGE and SHORT EDGE are shown in the illustration on page 26.

4 If you selected "2 TO 1" or "2 TO 2", press the [◀] key () or [▶] key () to select the original size and then press the [ENTER] key.

The following original sizes can be selected:
"A4", "B5", "A5", "8.5x14", "8.5x13", "8.5x11",
"5.5x8.5"

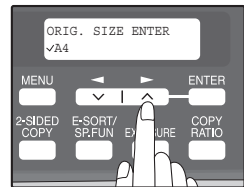

5 Select the number of copies and any other settings, and then press the [START] key ().

The copy will be delivered to the paper output tray.



To cancel automatic two-sided copying, press the [CLEAR ALL] key () or press the [2-SIDED COPY] key, select the "1 TO 1", and then press the [ENTER] key.

SORT COPY

Copies of multiple original pages can be sorted into sets.



The number of pages that can be scanned varies depending on the original type (photo, text, etc.) and the amount of memory allocated to the printer. The amount of memory allocated to the printer can be changed with "MEM. FOR PRINTER" in the user programs. (p.56)

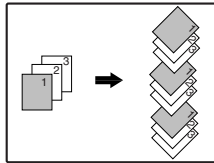

Sort copy

Using the document glass

1 Place the first original. (p.20)

2 Press the [E-SORT/SP.FUN] key until "SORT" appears and then press the [ENTER] key.

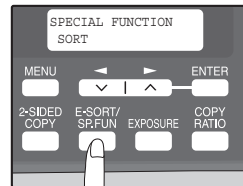

3 Press the [◀] key () to move "✓" to the "ON" position and then press the [ENTER] key.

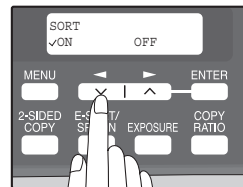

4 Select the number of copies and any other settings, and then press the [START] key ().

"[START] : NEXT SCAN [#] : START PRINT" appears and the original is scanned into memory.

5 Replace the original with the next original, and then press the [START] key ().

Repeat step 5 until all originals have been scanned into memory.



To clear the data in memory, press the [CLEAR] key (). When the [CLEAR] key () is pressed, the number of copies setting is also cleared.

6 When all originals have been scanned, press the [#] key.

The copies are delivered to the paper output tray.



- To cancel the sort copy job, press the [CLEAR] key ().
- To cancel sort copy mode, press the [CLEAR ALL] key ().

Using the RSPF (Option)

1 Place the originals. (p.21)



- If "SORT AUTO SELECT" is enabled in the user programs, the default output mode for copying from the RSPF is sort mode (p.57). In this case go directly to step 4. A checkmark "✓" will automatically appear in the display (p.11).
- If "SORT AUTO SELECT" is disabled, the default output mode will be non-sort mode. Follow the steps below to select sort mode.

2 Press the [E-SORT/SP.FUN] key until "SORT" appears and then press the [ENTER] key.

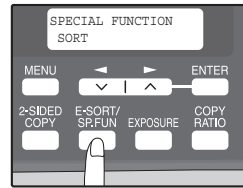

3 Press the [◀] key (☐) to move "✓" to the "ON" position and then the [ENTER] key.

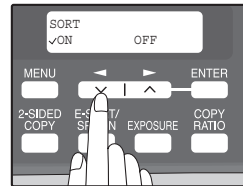

4 Select the number of copies and any other settings, and then press the [START] key (⊙).

The copies are delivered to the paper output tray.



- To cancel the sort copy job, press the [CLEAR] key (⊞).
- To cancel sort copy mode, press the [CLEAR ALL] key (⊞A).

If the memory becomes full

- If the memory becomes full while scanning the originals, "MEMORY FULL, PRESS START TO RESUME" will appear in the display, and the machine will stop copying.
- To copy the originals that have been scanned up to that point, press the [START] key (⊙).
- To clear the data that has been scanned into memory, press the [CLEAR ALL] key (⊞A) or the [CLEAR] key (⊞).

Offset function during sort copy

The offset function shifts the position of each set of copies in the paper output tray for easy separation.

The offset function can be changed with "OFFSET FUNCTION" in the user programs. (p.55)

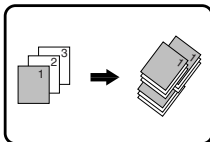

Offset function

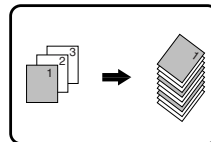

When offset function is disabled

COPYING MULTIPLE ORIGINALS ONTO A SINGLE SHEET OF PAPER (2 IN 1 copy)

Multiple originals can be copied onto a single sheet of paper in a selected layout pattern.

This function is convenient for compiling multi-page reference materials into a compact format, or for providing an overview of all pages of a document on a single page.

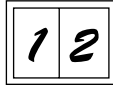

Pattern 1

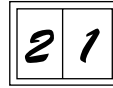

Pattern 2



- An appropriate ratio setting will be automatically selected based on the size of the originals, the size of the paper. When using the document glass, reduction is possible to 25%. When using the RSPF, reduction is possible to 50%. Certain combinations of original size and paper size may result in images being cut off.
- 2 IN 1 copying cannot be used in combination with the margin shift copying.
- The 2 IN 1 layout pattern can be changed with "LAYOUT IN 2IN1" in the user programs (p.55).
- The bypass tray cannot be used for 2 IN 1 copying.

Using the document glass

1 Place the first original. (p.20)

2 Press the [E-SORT/SP.FUN] key until "2IN1" appears and then press the [ENTER] key.

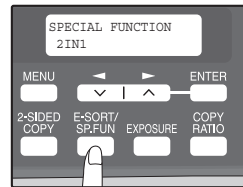

3 Press the [◀] key () to move "✓" to the "ON" position and then press the [ENTER] key.

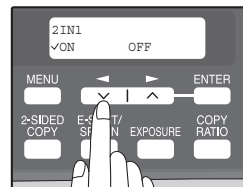

- 4** Press the [◀] key (◀) or [▶] key (▶) to select the original size and then press the [ENTER] key.

The following original sizes can be selected:
"A4", "B5", "A5", "8.5x14", "8.5x13", "8.5x11",
"5.5x8.5"

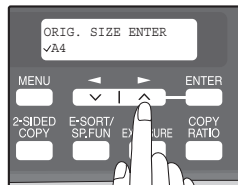

- 5** Select the number of copies and any other settings, and then press the [START] key (⊙).

"[START] : NEXT SCAN [#] : START PRINT" appears and the original is scanned into memory.

To immediately print the scanned image, press the [#] key.

- 6** Replace the original with the next original, and then press the [START] key (⊙).

Repeat step 6 until all originals have been scanned.

Copies will be output each time two originals have been scanned.

When the number of original pages is odd and "[START] : NEXT SCAN [#] : START PRINT" appears, press the [#] key after all pages have been scanned.



- To clear the data in memory, press the [CLEAR] key (C).
- When the [CLEAR] key (C) is pressed, the number of copies setting is also cleared.
- To cancel 2 IN 1 copying, press the [CLEAR] key (C).
- To cancel 2 IN 1 copy mode, press the [CLEAR ALL] key (CA).

Using the RSPF (Option)

1 Place the originals. (p.21)

2 Press the [E-SORT/SP.FUN] key until "2IN1" appears and then press the [ENTER] key.

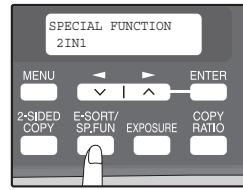

3 Press the [◀] key () to move "✓" to the "ON" position and then press the [ENTER] key.

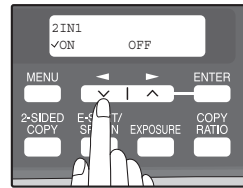

4 Press the [◀] key () or [▶] key () to select the original size and then press the [ENTER] key.

The following original sizes can be selected:
 "A4", "B5", "A5", "8.5x14", "8.5x13", "8.5x11",
 "5.5x8.5"

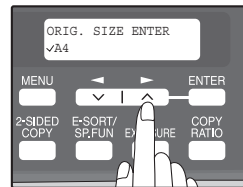

5 Select the number of copies and any other settings, and press the [START] key ().

The copy is delivered to the paper output tray.



- To cancel 2 IN 1 copying, press the [CLEAR] key ().
- To cancel 2 IN 1 copy mode, press the [CLEAR ALL] key ().

4

CREATING MARGINS WHEN COPYING

(Margin shift)

The margin shift function is used to automatically shift the text or image or the copy paper approximately 10 mm (1/2").

As shown below, LONG EDGE or SHORT EDGE can be selected.

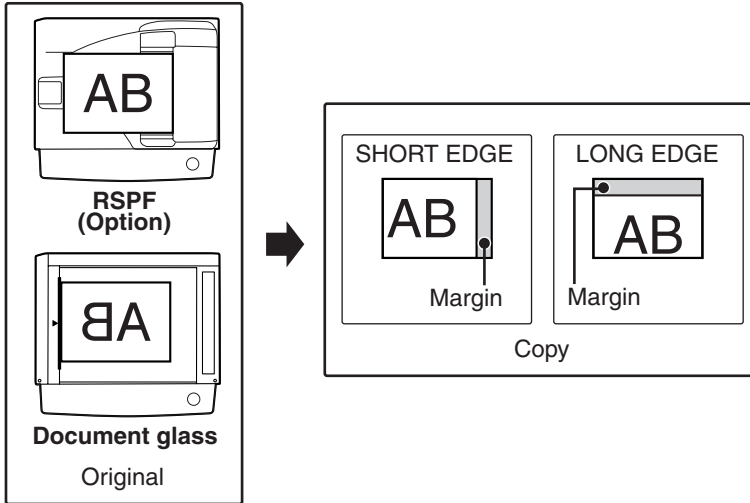



Note

- This feature cannot be used with the 2 IN 1 feature.
- The margin width can be changed with "MARGIN WIDTH" in the user programs. (p.56)
- Note that a margin is created by shifting the image, and thus if the image is shifted too far, the edge of the image may be cut off.

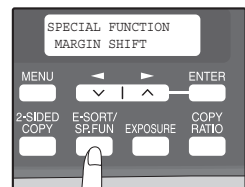

1 Place the original(s).

2 Press the [E-SORT/SP.FUN] key until "MARGIN SHIFT" appears and then press the [ENTER] key.

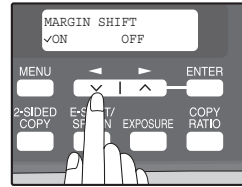

- 3** Press the [◀] key () to move "✓" to the "ON" position and then press the [ENTER] key.



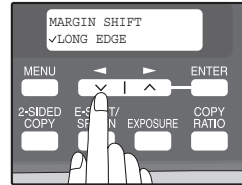

- 4** Press the [◀] key () or [▶] key () to select the margin position and then press the [ENTER] key.
 Select "LONG EDGE" or "SHORT EDGE".
 For the margin position, see the previous page.



- 5** Select the number of copies and any other settings, and then press the [START] key ().
 The copy is delivered to the paper output tray.



- To cancel margin shift copying, press the [CLEAR] key ().
- To cancel margin shift mode, press the [CLEAR ALL] key ().

This chapter explains how to install and configure the software that is required for the printer and scanner functions of the machine. The procedure for viewing the Online Manual is also explained.



This manual refers to the CD-ROM that accompanied the machine simply as "CD-ROM".

SOFTWARE

The CD-ROM that accompanies the machine contains the following software:

MFP driver

Printer driver

The printer driver enables you to use the printer function of the machine.

The printer driver includes the Print Status Window. This is a utility that monitors the machine and informs you of the printing status, the name of the document currently being printed, and error messages.

Scanner driver

The scanner driver allows you to use the scanning function of the machine with TWAIN-compliant and WIA-compliant applications.

Sharpdesk

Sharpdesk is an integrated software environment that makes it easy to manage documents and image files, and launch applications.

Button Manager

Button Manager allows you to use the scanner menus on the machine to scan a document.

BEFORE INSTALLATION

Hardware and software requirements

Check the following hardware and software requirements in order to install the software.

Computer type	IBM PC/AT or compatible computer equipped with a USB2.0 ^{*1} /1.1 ^{*2}
Operating system ^{*3} ^{*4}	Windows 98, Windows Me, Windows 2000 Professional ^{*5} , Windows XP ^{*5} , Windows Vista ^{*5}
Display	1024 x 768 dots resolution and 16-bit colour or higher is recommended.
Hard disk free space	150 MB or more
Other hardware requirements	An environment on which any of the operating systems listed above can fully operate

^{*1} The machine's USB connector will transfer data at the speed specified by the USB 2.0 (Hi-Speed) only if the Microsoft USB 2.0 driver is installed in the computer.

^{*2} Compatible with Windows 98, Windows Me, Windows 2000 Professional, Windows XP or Windows Vista preinstalled model standardly equipped with a USB port.

^{*3} Printing is not available in MS-DOS mode.

^{*4} The machine does not support printing from a Macintosh environment.

^{*5} Administrator's rights are required to install the software using the installer.

INSTALLING THE SOFTWARE



Note

- The screen images in this manual are mainly for Windows XP. With other versions of Windows, some screen images may be different from those in this manual.
- In the following explanations it is assumed that the mouse is configured for right hand operation.
- If an error message appears, follow the instructions on the screen to solve the problem. After the problem is solved, the installation procedure will continue. Depending on the problem, you may have to click the "Cancel" button to exit the installer. In this case, reinstall the software from the beginning after solving the problem.

1 The USB cable must not be connected to the machine. Make sure that the cable is not connected before proceeding.

If the cable is connected, a Plug and Play window will appear. If this happens, click the "Cancel" button to close the window and disconnect the cable.



Note

The cable will be connected in step 13.

2 Insert the CD-ROM into your computer's CD-ROM drive.

3 Click the "start" button, click "My Computer" () , and then double-click the CD-ROM icon ().

- In Windows Vista, click the "Start" button, click "Computer", and then double-click the CD-ROM icon.
- In Windows 98/Me/2000, double-click "My Computer", and then double-click the CD-ROM icon.

4 Double-click the "setup" icon ().

In Windows Vista, if a message screen appears asking you for confirmation, click "Allow".

5 The "SOFTWARE LICENSE" window will appear. Make sure that you understand the contents of the software license, and then click the "Yes" button.



Note

You can show the "SOFTWARE LICENSE" in a different language by selecting the desired language from the language menu. To install the software in the selected language, continue the installation with that language selected.

6 Read the "Readme First" in the "Welcome" window and then click the "Next" button.

- 7** To install all of the software, click the "Standard" button and go to step 12. To install particular packages, click the "Custom" button and go to next step.

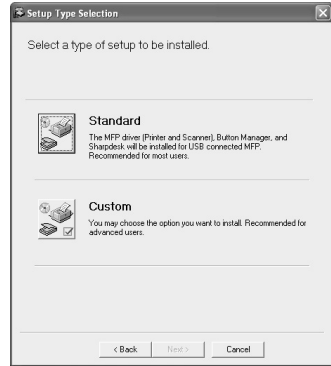

- 8** Click the "MFP Driver" button.

Click the "Display Readme" button to show information on packages that are selected.

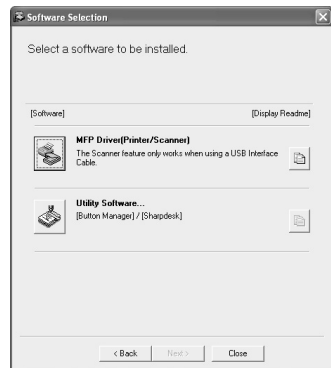

- 9** Select "Connected to this computer" and click the "Next" button.

Follow the on-screen instructions.

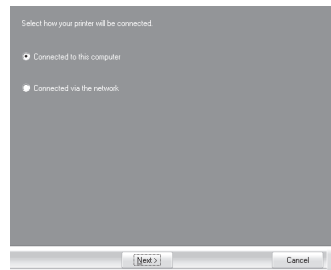

Caution

- If you are using Windows Vista and a security warning window appears, be sure to click "Install this driver software anyway".
- If you are running Windows 2000/XP and a warning message appears regarding the Windows logo test or digital signature, be sure to click "Continue Anyway" or "Yes".

10 You will return to the window of step 8. If you wish to install **Button Manager** or **Sharpdesk**, click the **"Utility Software"** button.

If you do not wish to install the Utility Software, click the "Close" button and go to step 12.



After the installation, a message prompting you to restart your computer may appear. In this case, click the "Yes" button to restart your computer.

Installing the Utility Software

11 Click the **"Button Manager"** or the **"Sharpdesk"** button.

Click the "Display Readme" button to show information on packages that are selected.

Follow the on-screen instructions.



In Windows 98/Me/2000, if the following screen appears, click the **"Skip"** button or the **"Continue"** button as appropriate to continue the Sharpdesk installation.

If "Skip" is selected, the Sharpdesk installation will continue without installing Sharpdesk Imaging.

If "Continue" is selected, Sharpdesk Imaging will be installed. If Imaging for Windows is installed on your computer, Sharpdesk Imaging will overwrite Imaging for Windows.

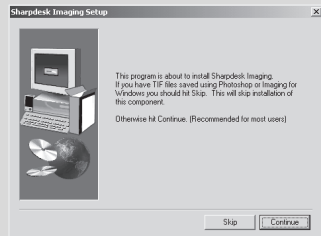

12 When installing is finished, click the "Close" button.



- If you are using Windows Vista and a security warning window appears, be sure to click "Install this driver software anyway".
- If you are running Windows 2000/XP and a warning message appears regarding the Windows logo test or digital signature, be sure to click "Continue Anyway" or "Yes".

A message will appear instructing you to connect the machine to your computer. Click the "OK" button.



After the installation, a message prompting you to restart your computer may appear. In this case, click the "Yes" button to restart your computer.

13 Make sure that the power of the machine is turned on, and then connect the USB cable (p.42).

Windows will detect the machine and a Plug and Play screen will appear.

14 Follow the instructions in the plug and play window to install the driver.

Follow the on-screen instructions.



- If you are using Windows Vista and a security warning window appears, be sure to click "Install this driver software anyway".
- If you are running Windows 2000/XP and a warning message appears regarding the Windows logo test or digital signature, be sure to click "Continue Anyway" or "Yes".

This completes the installation of the software.

- If you installed Button Manager, set up Button Manager as explained in "SETTING UP BUTTON MANAGER" (p.45).
- If you installed Sharpdesk, the Sharpdesk setup screen will appear. Follow the instructions in the screen to set up Sharpdesk.

INSTALLING THE SOFTWARE

Connecting a USB cable

Follow the procedure below to connect the machine to your computer. A USB cable for connecting the machine to your computer is not included with the machine. Please purchase the appropriate cable for your computer.

Caution

- USB is available with a PC/AT compatible computer that was originally equipped with USB and had Windows 98, Windows Me, Windows 2000 Professional, Windows XP or Windows Vista preinstalled.
- Do not connect the USB cable before installing the printer driver. The USB cable should be connected during installation of the printer driver.

Note

- If the machine will be connected using a USB 2.0 port of your computer, please purchase a USB cable that supports USB 2.0.
- To obtain the fastest USB 2.0 data transfer speed, "USB2.0 MODE SWITCH" in the machine's user programs must be set to "HI-SPEED". For more information, see "USER PROGRAMS" (p.58).
- Use the machine's "HI-SPEED" mode only when using a computer that is running Windows 2000/XP/Vista.
- Even when the Microsoft USB 2.0 driver is used, it may not be possible to obtain full USB 2.0 speed if a PC card supporting USB 2.0 is used. To obtain the latest driver (which may enable a higher speed), contact the manufacturer of your PC card.
- Connection is also possible using a USB 1.1 port on your computer. However, the specifications will be USB 1.1 specifications (Full-Speed).

- 1** Insert the cable into the USB connector on the machine.

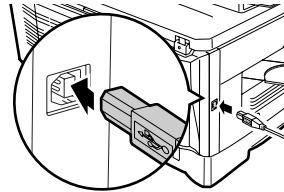

- 2** Insert the other end of the cable into your computer's USB port.

Using the machine as a shared printer

If the machine will be used as a shared printer on a network, follow these steps to install the printer driver in the client computer.



To configure the appropriate settings in the print server, see the operation manual or help file of your operating system.

1 Perform steps 2 through 6 in "INSTALLING THE SOFTWARE" (p.38).

2 Click the "Custom" button.

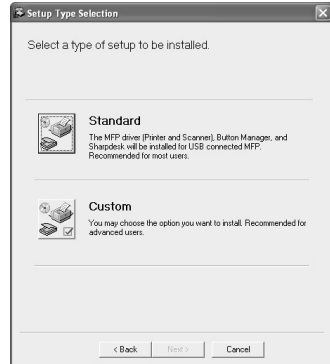

3 Click the "MFP Driver" button.

Click the "Display Readme" button to show information on packages that are selected.

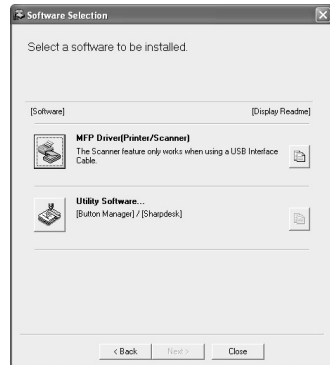

4 Select "Connected via the network" and click the "Next" button.

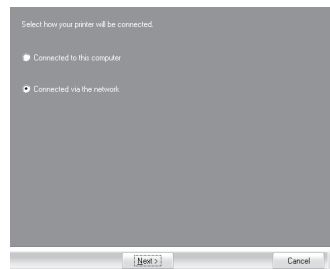

5 Click the "Add Network Port" button.

In Windows Vista, the "Add Network Port" button does not appear.

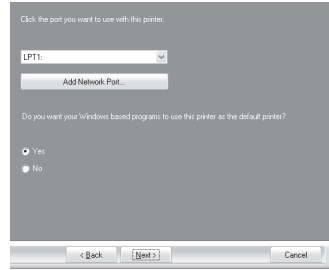

6 Select the network printer that is shared and click the "OK" button.

Ask your network administrator for the server name and printer name of the machine on the network.

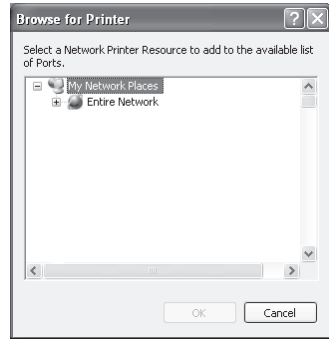

7 In the printer port selection window, verify the network printer that is shared and whether the machine is to be used as the default printer, make the selections and click the "Next" button.

Follow the on-screen instructions.

! Caution

- If you are using Windows Vista and a security warning window appears, be sure to click "Install this driver software anyway".
- If you are running Windows 2000/XP and a warning message appears regarding the Windows logo test or digital signature, be sure to click "Continue Anyway" or "Yes".

8 You will return to the window of step 3. Click the "Close" button.

Note

After the installation, a message prompting you to restart your computer may appear. In this case, click the "Yes" button to restart your computer.

This completes the installation of the software.

SETTING UP BUTTON MANAGER

Button Manager is a software program that works with the scanner driver to enable scanning from the machine.

To scan using the machine, Button Manager must be linked with the scan menu on the machine. Follow the steps below to link Button Manager to scanner events.

Windows XP/Vista

- 1** Click the "start" button, click "Control Panel", click "Printers and Other Hardware", and then click "Scanners and Cameras".

In Windows Vista, click the "Start" button, select "Control Panel" and click "Hardware and Sound", and then click "Scanners and Cameras".

- 2** Click the "SHARP AR-XXXX" icon and select "Properties" from the "File" menu.

In Windows Vista, select "Properties" from the "Organize" menu.

- 3** In the "Properties" screen, click the "Events" tab.

- 4** Select "SC1:" from the "Select an event" pull-down menu.

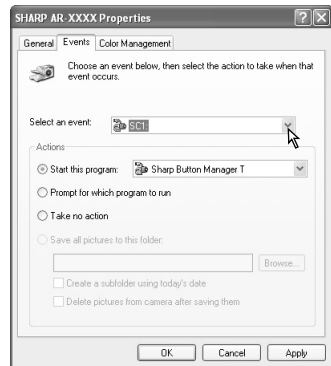

5

- 5** Select "Start this program" and then select "Sharp Button Manager T" from the pull-down menu.

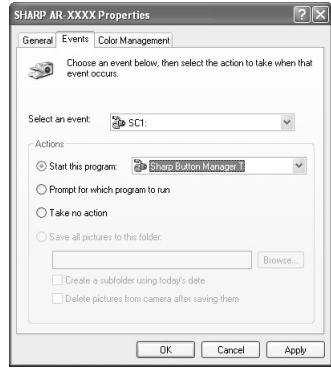

- 6** Click the "Apply" button.

- 7** Repeat Steps 4 through 6 to link Button Manager to "SC2:" through "SC6:".

Select "SC2:" from the "Select an event" pull-down menu. Select "Start this program", select "Sharp Button Manager T" from the pull-down menu, and then click the "Apply" button. Do the same for each ScanMenu through "SC6:".

When the settings have been completed, click the "OK" button to close the screen.

Button Manager is now linked to the scan menu (1 through 6).

The scan settings for each of scan menu 1 through 6 can be changed with the setting window of Button Manager.

For the factory default settings of the scan menu and the procedures for configuring Button Manager settings, see "Button Manager Settings" in the Online Manual.

Windows 98/Me/2000

1 Click the "Start" button, select "Settings", and then click "Control Panel".

2 Double-click the "Scanners and Cameras" icon.



If the "Scanners and Cameras" icon does not appear in Windows Me, click "view all Control Panel options".

3 Select "SHARP AR-XXXX" and click the "Properties" button.

In Windows Me, right click "SHARP AR-XXXX" and click "Properties" in the pop-up menu.

4 In the "Properties" screen, click the "Events" tab.

5 Select "SC1:" from the "Scanner events" pull-down menu.

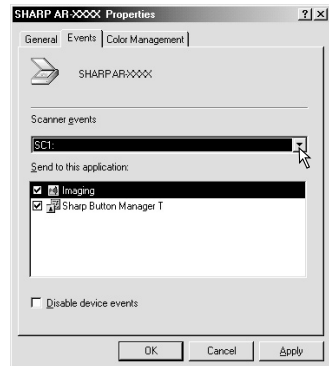

5

6 Select "Sharp Button Manager T" in "Send to this application".

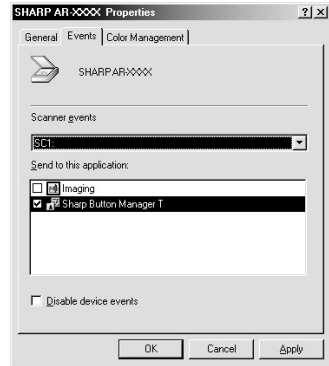

If other applications are shown, deselect the checkboxes for the other applications and leave only the Button Manager checkbox selected.

7 Click the "Apply" button.

8 Repeat Steps 5 through 7 to link Button Manager to "SC2:" through "SC6:".

Select "SC2:" from the "Scanner events" pull-down menu. Select "Sharp Button Manager T" in "Send to this application" and click the "Apply" button. Do the same for each ScanMenu through "SC6:". When the settings have been completed, click the "OK" button to close the screen.

Button Manager is now linked to the scan menu (1 through 6). The scan settings for each of scan menus 1 through 6 can be changed with the setting window of Button Manager. For the factory default settings of the scan menu and the procedures for configuring Button Manager settings, see "Button Manager Settings" in the Online Manual.

The machine includes a USB connector as standard equipment.

The machine has the following features:

- High-speed data transfer (when connected to a USB 2.0 connector)
- ROPM* function

* ROPM is an acronym for "Rip Once Print Many" processing. The ROPM function stores multiple pages of print data in memory before printing. When printing multiple copies, this eliminates the need for the computer to repeatedly transmit the print data.

To use the machine as a printer or scanner, the printer driver or scanner driver must first be installed as explained in the "INSTALLING THE SOFTWARE".

**Note**

- If a problem occurs in printer or scanner mode, see the Online Manual.
- When using USB 2.0 (Hi-Speed mode), be sure to read "System requirements for USB 2.0 (Hi-Speed mode)" (below) to verify that your system and the machine settings are configured appropriately.

System requirements for USB 2.0 (Hi-Speed mode)

The following system is required to use USB 2.0 (Hi-Speed mode):

- Your computer must be running Windows 2000 Professional/XP/Vista and the Microsoft USB 2.0 driver must be installed.
 - The "USB 2.0 MODE SWITCH" setting in the machine's user programs must be set to "HI-SPEED". To change the setting, see "USB 2.0 MODE SWITCH" in the user programs (p.58).
- * Even when the Microsoft USB 2.0 driver is installed, some USB 2.0 expansion cards are not capable of attaining the speed stipulated by the Hi-Speed standard. This problem can often be fixed by installing a more recent driver for the card. To obtain the most recent driver for your card, contact the card's manufacturer.

USING THE PRINTER MODE

The procedure for loading paper for printing is the same as for loading copy paper. See "LOADING PAPER" (p.14).



- Print jobs received while the machine is copying will be stored in memory. When the copy job is finished, the print jobs will begin printing.
- Printing is not possible when the front or side cover is opened for machine maintenance, or when a misfeed occurs or the machine runs out of paper or toner.

BASIC PROCEDURE FOR PRINTING

The basic procedure for printing is explained in the following. To use convenient printer functions, see the "Online Manual" or the printer driver help file.

1 Make sure that paper is loaded in the tray.

The procedure for loading paper is the same as for copying. See "LOADING PAPER" (p.14) and make sure that the paper you wish to use is loaded.



Make sure that the paper size setting on the machine is the same as the paper size set in the printer driver.

2 Open the file that you wish to print and select "Print" from the File menu.

3 Make sure that the printer driver for the machine is selected, and select print settings in the printer driver.

For information on the settings in the printer driver, see the "Online Manual" or the printer driver help file.

4 Click the "Print" button or the "OK" button to begin printing.

The print job will be delivered to the paper output tray.

Canceling a print job

1 Select printer mode with the [MODE SELECT] key on the operation panel of the machine, and then press the [CLEAR] key (C) or the [CLEAR ALL] key (CA).

2 "CANCEL PRINT JOB?" will appear in the display. Make sure that a checkmark appears in front of "YES" and press the [ENTER] key.



For limitations on copying in print mode, scanner mode limitations, and print mode limitations in copy and scanner mode, see "OPERATION IN COPY, PRINTER, AND SCANNER MODES" (p.52).

USING THE SCANNER MODE

The procedure for placing the original is the same as for copying. See "NORMAL COPYING" (p.20).



Scanner mode cannot be used at the following times:

- A misfeed has occurred (paper misfeed or original misfeed in the RSPF).
- The user programs are being used.
- The tray paper size is being set.
- The machine is being used in copy mode.
- The front cover or side cover is open.

SCANNING USING THE KEYS ON THE MACHINE

When scanning is performed by this method, the application that has been set in Button Manager will automatically start and the scanned image will be pasted into the application.



If the machine is in copy mode, press the [MODE SELECT] key to switch to scanner mode and clear the previously set copy settings.

Scanning from the operation panel of the machine

- 1 Press the [MODE SELECT] key to select scanner mode.**

The "SCAN" indicator lights up to indicate that scanner mode is selected.

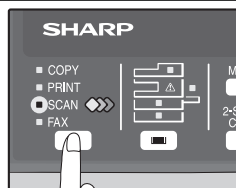

- 2 Place the original. (p.20)**

- 3 Press the [◀] key () or [▶] key () to select the desired Button Manager scan menu setting.**

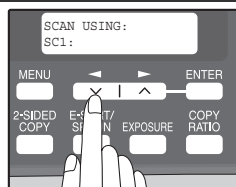

- 4 Press the [START] key () to begin scanning.**



Scanner mode remains selected after scanning is finished. (To change to a different mode, use the [MODE SELECT] key.)

Button Manager scan menu

For information on Button Manager settings, see the Button Manager help file. The names in the Button Manager menu ("xxxx" in "SC1:xxxx", etc.) can be changed. See the online manual.

SCANNING FROM YOUR COMPUTER

The machine supports the TWAIN standard, making it possible to scan from TWAIN-compliant applications. The machine also supports WIA (Windows Image Acquisition), making it possible to scan from the "Scanner and Camera Wizard" in Windows XP. See the Online Manual for the procedures for TWAIN and WIA scanning. For information on TWAIN and WIA settings, see the help file for the scanner driver or Windows Help.

OPERATION IN COPY, PRINTER, AND SCANNER MODES

Some operations cannot be performed simultaneously when the machine is being used in printer mode, copy mode, or scanner mode.

Modes		Copying	Printing	Scanning from a computer	Scanning from the machine
Copy	Copy key input	Yes	Yes	Yes	No
	During copying		No	No	No
Printer	During printing	Yes*		Yes	Yes
Scanner	During scan preview/ during scanning	No	Yes		

* During two-sided printing, the copy job begins after the print job finishes.

HOW TO USE THE ONLINE MANUAL

The online manual provides detailed instructions for operating the unit as a printer and scanner. It also provides methods for dealing with printing or scanner problems.

1 Turn on your computer.

2 Insert the supplied CD-ROM into your CD-ROM drive.

3 Click the "start" button, click "My Computer" () , and then double-click the CD-ROM () icon.

- In Windows Vista, click the "Start" button, click "Computer", and then double-click the CD-ROM icon.
- In Windows 98/Me/2000, double-click "My Computer" and then double-click the CD-ROM icon.

4 Double-click the "Manual" folder, double-click the "English" folder, and then double-click the "AR_M201.pdf" icon.

5 Click  to read the online manual.

To close the online manual, click the () button located at the top-right of the window.



Note

- The online manual can be printed out using Acrobat Reader. It is useful to print out sections that you refer to frequently.
- Refer to Acrobat Reader "Help" for more details on the operation and functions of Acrobat Reader.

Viewing the online manual

The "CD-ROM" that accompanies the machine contains an online manual in PDF format. To view the manual in PDF format, Acrobat Reader or Adobe Reader of Adobe Systems Incorporated is required. If neither program is installed on your computer, the programs can be downloaded from the following URL:

<http://www.adobe.com/>

7 Chapter 7 USER SETTINGS

The user settings allow you to customize machine settings to better meet your needs.



USER PROGRAMS

The user settings consist of the following items.

To change a user program setting, see "SELECTING A SETTING FOR A USER PROGRAM" (p.59).

Copy mode

Program number	Program name	Setting codes (factory default setting appears in bold)	Explanation
1	AUTO CLEAR	1: 10 SEC. 2: 30 SEC. 3: 60 SEC. 4: 90 SEC. 5: 120 SEC. 6: OFF	<ul style="list-style-type: none">• Auto clear time automatically returns the copy settings to the initial settings (p.12) if no keys are pressed for a preset period of time following the end of a copy job.• This program is used to select the period of time. Auto clear time can also be disabled.
2	PREHEAT MODE	1: 30 SEC. 2: 1 MIN. 3: 5 MIN. 4: 30 MIN. 5: 60 MIN. 6: 120 MIN. 7: 240 MIN.	<ul style="list-style-type: none">• This function automatically switches the machine to a low power consumption state if the set duration of time elapses without the machine being used when the power is on. The power save indicator lights up, however, the keys on the operation panel can be used. Normal operation automatically resumes when a key on the operation panel is pressed, an original is placed, a print job is received.
3	AUTO SHUT-OFF	1: ON 2: OFF	<ul style="list-style-type: none">• Use this setting to enable or disable auto power shut-off mode.

Program number	Program name	Setting codes (factory default setting appears in bold)	Explanation
4	AUTO SHUT-OFF TIME	1: 5 MIN. 2: 30 MIN. 3: 60 MIN. 4: 120 MIN. 5: 240 MIN.	<ul style="list-style-type: none"> This function automatically switches the machine to a state that consumes even less power than preheat mode if the set duration of time elapses without the machine being used when the power is on. All lights except the power save indicator go off. To resume normal operation, press the [START] key (). Normal operation also resumes automatically when a print job is received or scanning is begun from a computer. While in auto power shut-off mode, no keys (except the [START] key ()) can be used.
7	LAYOUT IN 2IN1	1: PATTERN 1 2: PATTERN 2	<ul style="list-style-type: none"> Use this setting to select the layout pattern when two original pages are copied onto a single sheet of paper (see page 31 for the layout patterns).
8	OFFSET FUNCTION	1: ON 2: OFF	<ul style="list-style-type: none"> When enabled, this function offsets the position of each set of copies in the output tray in copy mode, and each print job in printer mode.
9	ROTATE ORIG. IMAGE	1: ON 2: OFF	<ul style="list-style-type: none"> When two-sided copying is performed, this function rotates the image on the back of the original. This is convenient when binding the copies at the top (tablet binding).
10	AE/TEXT RESOLUTION	1: 300dpi 2: 600dpi	<ul style="list-style-type: none"> This setting is used to change the copy resolution in AUTO and TEXT mode from 600 x 300 dpi to 600 x 600 dpi (high-quality mode). Scanning is slower when high-quality mode is used.

USER SETTINGS

Program number	Program name	Setting codes (factory default setting appears in bold)	Explanation
11	2-SIDED COPY MODE	1: HI-SPEED 2: NORMAL	<ul style="list-style-type: none"> If the memory fills up when two-sided copying is performed, "NORMAL" can be selected to make copying possible. However, "NORMAL" results in a slower copying speed. Normally "HI-SPEED" is selected to enable fast two-sided copying.
12	MARGIN WIDTH	1: 5 mm (1/4") 2: 10 mm (1/2") 3: 15 mm (3/4") 4: 20 mm (1")	<ul style="list-style-type: none"> Use this setting to set the margin width.
13	MEM. FOR PRINTER	1: 30% 2: 40% 3: 50% 4: 60% 5: 70%	<ul style="list-style-type: none"> Use this to change the proportion of machine memory used for printer mode.
14	AUTO KEY REPEAT	1: ON 2: OFF	<ul style="list-style-type: none"> Use this setting to select whether or not holding down a key causes repeated input of the key. For keys that normally cause a set value to decrease or increase when held down (for example, the [◀] key (◀) or [▶] key (▶)), this program can be used to have the set value not change when the key is held down.
15	KEY PRESS TIME	1: NORMAL 2: 0.5 SEC. 3: 1.0 SEC. 4: 1.5 SEC. 5: 2.0 SEC.	<ul style="list-style-type: none"> Use this setting to select how long a key must be pressed for the input to be accepted. By selecting a longer time, you can prevent settings from being changed by the accidental pressing of a key.
16	KEY TOUCH SOUND	1: LOW 2: HIGH 3: OFF	<ul style="list-style-type: none"> This sets the volume of beep signals. (p.60)
17	SOUND AT DEFAULT	1: ON 2: OFF	<ul style="list-style-type: none"> Use this to sound a beep when a base setting is selected. (p.60)
18	TONER SAVE MODE	1: ON 2: OFF	<ul style="list-style-type: none"> This mode reduces toner usage by about 10% when copying. Toner save mode is effective when the exposure mode is AUTO or TEXT.

Program number	Program name	Setting codes (factory default setting appears in bold)	Explanation
19	AE LEVEL ADJUST	1: SPF/RSPF (Adjustment to 5 levels is possible.) 2: DOCUMENT GLASS (Adjustment to 5 levels is possible.)	<ul style="list-style-type: none"> This is used to adjust the exposure level. The automatic exposure level can be adjusted separately for the document glass and the RSPF. For the procedure for adjusting the exposure and guidelines for numeric values, see page 24. The factory default setting for the exposure level is centre.
20	LANGUAGE	1: AMERICAN ENGLISH 2: ENGLISH 3: FRENCH 4: SPANISH	<ul style="list-style-type: none"> This is used to set the language used in the display.
21	RESET FACTORY	1: YES 2: NO	<ul style="list-style-type: none"> This is used to return all settings to the factory default settings.
22	SORT AUTO SELECT	1: ON 2: OFF	<ul style="list-style-type: none"> Use this setting to enable or disable sort auto select mode.
24	<ul style="list-style-type: none"> CHECK OC OPEN CHECK RSPF OPEN (When an RSPF is installed.) 	1: ON 2: OFF	<ul style="list-style-type: none"> You can set the operation that takes place if the [START] key (⊙) is pressed when the original cover/RSPF is not completely closed. (For details on the "Check original cover/RSPF open function", see page 14.)
25	VALID COPY WIDTH	1: A4 (8.5x11) 2: B5R (5.5x8.5)	<ul style="list-style-type: none"> Set the allowed paper sizes for copying from the bypass tray. When "B5R (5.5x8.5)" is selected, a copy of an A4 (letter) size original will only be printed up to B5R (invoice) size.
28	LSU SETTING	1: ON 2: OFF	<ul style="list-style-type: none"> Select whether copying is only allowed when the polygon motor is rotating, or also when the polygon motor is stopped.
29	PAPER TYPE	1: PLAIN PAPER 2: HEAVY PAPER	<ul style="list-style-type: none"> Set the temperature of the fusing unit when the bypass tray is used.
30	DISPLAY CONTRAST	1: LIGHTER 2: LIGHT 3: NORMAL 4: DARK 5: DARKER	<ul style="list-style-type: none"> Set the contrast of the display.

Print mode

Program number	Program name	Setting codes (factory default setting appears in bold)	Explanation
1	FORCED OUTPUT	1: ON 2: OFF	<ul style="list-style-type: none"> When this function is enabled, printing in printer mode will automatically continue using a different size of paper if the specified size of paper runs out in all trays. This feature does not function in copy mode.
2	USB 2.0 MODE SWITCH* ¹	1: FULL-SPEED 2: HI-SPEED	<ul style="list-style-type: none"> This sets the USB 2.0 data transfer speed. To obtain the fastest speed when using the USB 2.0 connector, first verify that your computer meets the system requirements (operating system and driver), and then use this program to change the USB 2.0 mode to "Hi-Speed". Note that the setting should not be changed while running a TWAIN driver. (For the system requirements, see "System requirements for USB 2.0 (Hi-Speed mode)" (p.49).)
3	AUTO TRAY SWITCH* ²	1: ON 2: OFF	<ul style="list-style-type: none"> If the paper runs out during printing and there is paper of the same size in another tray, this function automatically switches to that tray (excluding the bypass tray). The function can be disabled.

*¹ The scanning speed increases when the USB 2.0 mode is set to "HI-SPEED", however, the printing speed does not increase considerably.

*² When the 250-sheet paper feed unit is installed.

SELECTING A SETTING FOR A USER PROGRAM

- 1 Press the [MENU] key and then press the [ENTER] key.**

In printer mode, the user programs are accessed by simply pressing the [MENU] key.

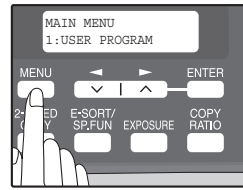

- 2 Press the [◀] key (▽) or [▶] key (△) to select the item that you wish to configure in the USER PROGRAM items, and then press the [ENTER] key.**

- See "USER PROGRAM" (p.54 to p.58) for the program name and program code.
- You can also select a program by directly entering the program number with the numeric keys.

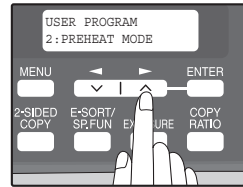

- 3 Press the [◀] key (▽) or [▶] key (△) to change the setting of the selected item.**

See "USER PROGRAM" (p.54 to p.58) for the program code.

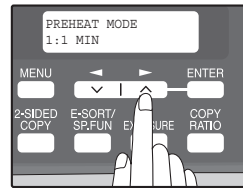

Note

- If you mistakenly select the wrong item, press the [CLEAR] key (□) and repeat the procedure from step 2.
- To cancel a setting for a user program, press the [MENU] key.

- 4 Press the [ENTER] key.**

Your selection appears briefly and then the previous screen appears.



Note

When "AE LEVEL ADJUST" is selected in the user programs and the [ENTER] key is pressed, the automatic exposure adjustment screen appears. Adjust the exposure and press the [ENTER] key.

USER SETTINGS

Audible signals (key entry beep, invalid key beep, base setting beep)

The machine sounds three different types of beep signals: a key entry beep that sounds when a valid key is pressed, an invalid key beep that sounds when an invalid key is pressed, and a base setting beep that sounds when a setting is the same as the base setting (base settings are explained below). The base setting beep is initially disabled. If you wish to enable the base setting beep, see "SOUND AT DEFAULT" on page 56. If you wish to change the volume of the beep signals or disable them, see "KEY TOUCH SOUND" on page 56.

The beep patterns of each type of beep signal are as follows:

Key entry beep One beep **Invalid key beep** Two beeps
Base setting beep Three beeps

Base settings

The base settings are preset standard selections for each copy setting. The base settings are as follows:

Copy ratio 100% **Paper feed location** Tray 1
Light and Dark level Centre (Upper paper tray)
AUTO/TEXT/PHOTO AUTO

Problems related to general use of the machine, the copy function, and software setup are explained here. Be sure to check the problem carefully before calling for service, as many problems can be solved by the user.

If you are unable to solve the problem, turn off the main switch, unplug the power cord from the outlet, and contact your authorised service representative.



For problems related to the printer and scanner functions, see the online manual.

DISPLAY MESSAGES

When the following indicators light up or blink on the operation panel or the following alphanumeric codes appear in the display, solve the problem immediately referring to both the table below and the indicated page.



Be sure to use only genuine SHARP parts and supplies.

Indication		Cause and remedy	Page	
Lamp indicator	Display			
Tray location indicator	Blinks	BYPASS : ADD PAPER	15	
		TRAY<*> : ADD PAPER		
		CLOSE PAPER TRAY<*>		
Error indicator	Blinks	CLEAR PAPER JAM.	70	
		SPF/RSPF JAM.		
		FRONT OR SIDE COVER OPEN. CLOSE COVERS.	-	
		CLOSE THE SPF/RSPF COVER.	-	
		REPLACE THE TONER CARTRIDGE.	74	
		SYSTEM ERROR [XX - XX] REFER TO USER GUIDE	When [L1-00] appears, the scan head locking switch is locked. Turn off the power, release the scan head locking switch, and turn the power back on.	76
			When [F2-02] appears, check the toner cartridge and make sure that the seal is not still affixed.	-
	The machine will not function. Turn the power switch off, wait about 10 seconds, and then turn on the switch again. If this does not clear the error, remove the power cord from the outlet, and contact your authorised service representative.	-		

TROUBLESHOOTING AND MAINTENANCE

Indication		Cause and remedy	Page
Lamp indicator	Display		
Error indicator	Blinks	INSTALL A TONER CARTRIDGE. The toner cartridge is not installed correctly. Reinstall the toner cartridge.	74
	Steadily lit	TONER CARTRIDGE IS NEAR EMPTY. Replacement of toner cartridge will be needed soon. Prepare a new cartridge.	74
		MAINTENANCE REQUIRED CALL FOR SERVICE Service by an authorised SHARP service technician is required.	-
MEMORY FULL, PRESS START TO RESUME.		Data is being held in memory. Print the data or clear it from memory.	30
NO 2-SIDED COPY FROM BYPASS TRAY.		Two sided printing or 2 IN 1 copying is selected when the bypass tray is already selected ,or the bypass tray is selected when two-sided printing or 2 IN 1 copying is already selected. The bypass tray cannot be used. Press the [TRAY SELECT] key (☐) to select a paper tray.	26 31
NO 2IN1 COPY FROM BYPASS TRAY.			
NO 2IN1 COPY WITH MARGIN SHIFT.		2 IN 1 copy and margin shift cannot be used in combination. Cancel the function that was selected last.	31 34
COPY RATIO CAN NOT BE CHANGED IN 2IN1.		Copy ratio can not be changed in 2 IN 1 copy.	25 31
THIS MENU IS NOT SELECTABLE WITH DATA.		This appears if you attempt to change a user program setting while a print job is in progress.	54
NO XXXX SIZE TRAY		There is no paper for printing. Press the [MODE SELECT] key to switch to printer mode and follow the instructions in the display. ("XXXX" indicates paper size)	-
CHECK SPF/RSPF. START TO RESUME.		An original remains on the document glass, or the original is too thick to scan. Remove the original.	21
		If the message is not cleared when there is no original on the document glass, the underside of the original cover/RSPF is dirty. Clean the underside of the original cover/RSPF. (especially areas where black lines appear.)	78
LOAD XXXX PAPER INTO TRAY<*>.		Printing is not possible if the paper size setting is different from the size of paper loaded in the tray. Load the same size of paper as the paper size setting and then press the [START] key (⊙). Printing will begin. ("XXXX" indicates paper size. The tray is indicated in <*>.)	15
NO PC COMMUNICATION; CHECK CABLE.		The machine is not correctly connected to the computer. Check the cable (when using the scanner function).	42

TROUBLESHOOTING THE MACHINE

The following problems are related to the general operation of the machine and copying.

Problem	Cause and solution	Page
The machine does not operate.	The machine is not plugged into a power outlet. → Plug the machine into a grounded outlet.	-
	Power switch OFF. → Turn the power switch ON.	12
	The power save indicator is blinking. Indicates that the machine is warming up. → Copies cannot be made until the machine has finished warming up.	-
	The front cover or the side cover is not completely closed. → Close the front cover or the side cover.	-
	The machine is in auto power shut-off mode. → In auto power shut-off mode, all lights are off except the power save indicator. Press the [START] key (⊙) to resume normal operation.	13
	The scan head locking switch is locked. → Unlock the scan head locking switch.	76
Copies are too dark or too light.	Select the correct original type for the original. → Select AUTO with the [EXPOSURE] key or press the [◀] key (▽) or [▶] key (△) to manually select an appropriate exposure.	24
	→ If the copy is too light or too dark even though AUTO was selected with the [EXPOSURE] key, adjust the automatic exposure level.	57
Blank copies.	The original is not placed face up in the RSPF or face down on the document glass. → Place the original face up in the RSPF or face down on the document glass.	20, 21
	The scan head locking switch is locked. → Unlock the scan head locking switch.	76

TROUBLESHOOTING AND MAINTENANCE

Problem	Cause and solution	Page
Part of the image is cut off or there is too much blank space.	The original was not placed in the correct position. → Place the original correctly.	20, 21
	An appropriate ratio was not used for the size of the original and the size of the paper. → Press the [COPY RATIO] key to change the ratio to a setting that is suitable for the original and the copy paper.	25
	The size of paper loaded in the tray was changed without changing the tray's paper size setting. → Be sure to change the tray's paper size setting whenever you change the size of paper loaded in the tray.	19
Wrinkles appear in the paper or the image disappears in places.	The paper is outside of the specified size and weight range. → Use copy paper within the specified range.	14
	Paper curled or damp. → Do not use curled or crimped paper. Replace with dry copy paper. During periods when the machine is not used for a long time, remove the paper from the tray and store it in a dark place in a bag to prevent moisture absorption.	-
Copies are smudged or dirty.	The document glass or the underside of the original cover/RSPF is dirty. → Clean regularly.	78
	Original smudged or blotchy. → Use a clean original.	-
Images rub off the copy easily.	The fusing temperature is not appropriate. → In the user programs, set "PAPER TYPE" (program 29) to "2 (HEAVY PAPER)".	57
Printing is not uniform between the edges of the paper and the centre.	The fusing temperature is not appropriate. → In the user programs, set "PAPER TYPE" (program 29) to "1 (PLAIN PAPER)".	57

Problem	Cause and solution	Page
Paper misfeed.	Misfeed occur. → To remove the misfeed, see "MISFEED REMOVAL".	70
	The paper is outside of the specified size and weight range. → Use copy paper within the specified range.	14
	Paper curled or damp. → Do not use curled or crimped paper. Replace with dry copy paper. During periods when the machine is not used for a long time, remove the paper from the tray and store it in a dark place in a bag to prevent moisture absorption.	-
	Paper is not loaded properly. → Make sure that the paper is properly loaded.	15
	Pieces of paper inside machine. → Remove all pieces of misfed paper.	71
	Too much paper is loaded in the tray. → If the stack of paper is higher than the indicator line on the tray, remove some of the paper and reload so that the stack does not exceed the line.	15
	Some sheets of paper stick together. → Fan the paper well before loading it.	15
	The guides on the bypass tray do not match the width of the paper. → Adjust the guides to match the width of the paper.	18
	The bypass tray extension is not opened. → When loading a large size of paper, open the extension.	18
White or black lines appear on copies.	The scanner glass for the RSPF is dirty. → Clean the long, narrow scanning window.	78
	The transfer charger is dirty. → Clean the transfer charger.	79



TROUBLESHOOTING AND MAINTENANCE

Problem	Cause and solution	Page
Paper size for a paper tray cannot be set.	Copying or printing is performed. → Set the paper size after copying or printing is complete.	-
	The machine has stopped temporarily due to running out of paper or a misfeed. → Load paper or remove the misfeed, and then set the paper size.	15, 19, 70
Output does not stack neatly in the paper output tray.	Both ends of the paper are curled upward. → Turning the paper over in the paper tray may help.	15
A copy job stops before it is finished.	"MEMORY FULL, PRESS START TO RESUME." appears in the display. → The memory became full during sort copy. Copy only the originals that have been scanned to that point, or cancel the job and clear the data from memory.	30
	The tray is out of paper. → Load paper.	15
The power save indicator is lit.	Other indicators are lit. → If other indicators are lit, the machine is in preheat mode. Press any key on the operation panel to resume normal operation.	13
	Only the power save indicator is lit. → If only the power save indicator is lit, the machine is in auto power shut-off mode. Press the [START] key (⊙) to resume normal operation.	13
Error indicator (⚠) is lit or blinking.	See "DISPLAY MESSAGES" to check the meaning of the error indicator and error message in the display, and take appropriate action.	61
Lighting fixture flickers.	The same power outlet is used for the lighting fixture and the machine. → Connect the machine to a power outlet which is not used for other electric appliances.	-

PROBLEMS DURING SETUP OF THE SOFTWARE

If the software does not install correctly, check the following items on your computer. To remove the software, see "Removing the software" (p.69).

MFP driver cannot be installed (Windows 2000/XP)

If the MFP driver cannot be installed in Windows 2000/XP, follow these steps to check your computer's settings.

1 Click the "start" button and then click "Control Panel".

In Windows 2000, click the "Start" button, select "Settings", and then click "Control Panel".

2 Click "Performance and Maintenance", and then click "System".

In Windows 2000, double-click the "System" icon.

3 Click the "Hardware" tab and then click the "Driver Signing" button.

4 Check "What action do you want Windows to take?" ("File signature verification" in Windows 2000).

If "Block" has been selected, it will not be possible to install the MFP driver. Select "Warn" and then install the MFP driver as explained in "INSTALLING THE SOFTWARE".



Plug and play screen does not appear

If the Plug and Play screen does not appear after you connect the machine to your computer with a USB cable and turn on the machine, follow the steps below to verify that the USB port is available.

1 Click the "start" button, click "Control Panel", and then click "Performance and Maintenance".

- In Windows Vista, click the "Start" button, select "Control Panel", and then click "System and Maintenance".
- In Windows 98/Me/2000, click the "Start" button, select "Settings", and then click "Control Panel".

2 Click "System", click the "Hardware" tab, and click the "Device Manager" button.

- In Windows Vista, click the "Device Manager", and if a message screen appears asking you for confirmation, click "Continue".
- In Windows 2000, double-click the "System" icon, click the "Hardware" tab, and click the "Device Manager" button.
- In Windows 98/Me, double-click the "System" icon and click the "Device Manager" tab.
- "Universal Serial Bus controllers" will appear in the list of devices.



If the "System" icon does not appear in Windows Me, click "view all Control Panel options".

3 Click the icon beside "Universal Serial Bus controllers".

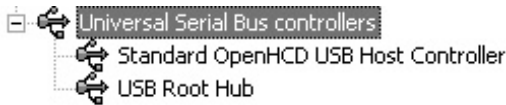

Two items should appear: your controller chipset type and Root Hub. If these items appear, you can use the USB port. If the "Universal Serial Bus controllers" shows a yellow exclamation point or does not appear, you must check your computer manual for USB troubleshooting or contact your computer manufacturer.

4 Once you have verified that the USB port is enabled, install the software as explained in "INSTALLING THE SOFTWARE".

The MFP driver cannot be correctly installed by Plug and Play (Windows 2000/XP/Vista)

In Windows 2000/XP/Vista, if the MFP driver cannot be correctly installed by Plug and Play (for example, Plug and Play takes place without copying the required files for the MFP driver installation), follow these steps to remove unneeded devices and then install the MFP driver as explained in "INSTALLING THE SOFTWARE" (p.36).

1 Click the "start" button, click "Control Panel", and then click "Performance and Maintenance".

- In Windows Vista, click the "Start" button, select "Control Panel", and then click "System and Maintenance".
- In Windows 2000, click the "Start" button, select "Settings", and then click "Control Panel".

2 Click "System", click the "Hardware" tab, and click the "Device Manager" button.

- In Windows Vista, click the "Device Manager", and if a message screen appears asking you for confirmation, click "Continue".
- In Windows 2000, double-click the "System" icon, click the "Hardware" tab, and click the "Device Manager" button.

3 Click the icon beside "Other devices".

If "AR-XXXX" and "SHARP AR-XXXX" appear, select and delete both of these items.



If "Other devices" does not appear, close the "Device Manager" window.

4 Install the software as explained in "INSTALLING THE SOFTWARE".

Removing the software

If you need to remove the software, follow these steps.

1 Click the "start" button and then click "Control Panel".

In Windows 98/Me/2000, click the "Start" button, select "Settings", and then click "Control Panel".

2 Click "Add or Remove Programs".

- In Windows Vista, click the "Uninstall a program".
- In Windows 98/Me/2000, double-click the "Add/Remove Programs" icon.

3 Select "SHARP AR-208/M200 Series MFP Driver" and Button Manager from the list, and remove the software.

For more information, refer to your operating manual or to the help files for your operating system.

MISFEED REMOVAL

When a misfeed occurs, the error indicator blinks, "CLEAR PAPER JAM" appears in the display, and the machine stops operating. If a misfeed occurs when using the RSPF, "RETURN X ORIGINAL(S) START TO RESUME" will appear in the display. ("X" indicates the number of pages to be returned.) This indicates the number of the originals that must be returned to the document feeder tray after a misfeed. Return the required number of originals. This number will be cleared when copying is resumed or the [CLEAR] key () is pressed. If an original misfeed occurs in the RSPF, the machine will stop and the error indicator will blink. To remove a misfeed from the RSPF, see "D: Misfeed in the RSPF (Option)" (p.73).

- 1** Open the bypass tray, and then open the side cover.

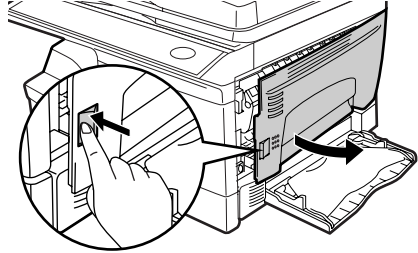

- 2** Check the misfeed location. Remove the misfed paper following the instructions for each location in the illustration below. If the error indicator blinks, proceed to "A: Misfeed in the paper feed area" (p.71).

If the misfed paper is seen from this side, proceed to "**C: Misfeed in the transport area**". (p.72)

If paper is misfed here, proceed to "**B: Misfeed in the fusing area**". (p.71)

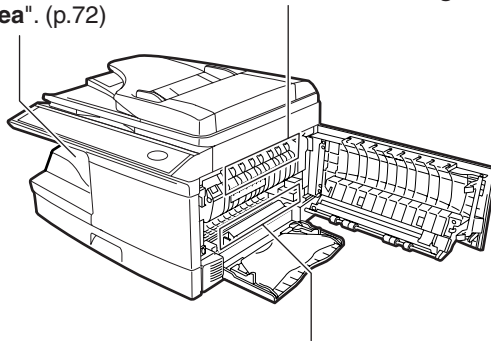

If paper is misfed here, proceed to "**A: Misfeed in the paper feed area**". (p.71)

A: Misfeed in the paper feed area

- 1** Gently remove the misfed paper from the paper feed area as shown in the illustration. If the error indicator blinks and the misfed paper is not visible in the paper feed area, pull out the paper tray and remove the misfed paper. If the paper cannot be removed, proceed to "B: Misfeed in the fusing area".



Warning The fusing unit is hot. Do not touch the fusing unit when removing misfed paper. Doing so may cause a burn or other injury.



- Do not touch the photoconductive drum (green portion) when removing the misfed paper. Doing so may damage the drum and cause smudges on copies.
- If the paper has been fed through the bypass tray, do not remove the misfed paper through the bypass tray. Toner on the paper may stain the paper transport area, resulting in smudges on copies.

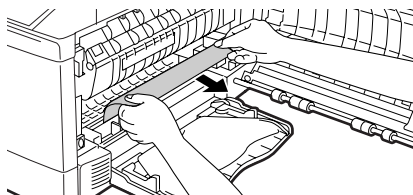

- 2** Close the side cover by pressing the round projections near the side cover open button. The error indicator will go out and the ready indicator will light up.

B: Misfeed in the fusing area

- 1** Lower the fusing unit release lever.

Fusing unit release lever

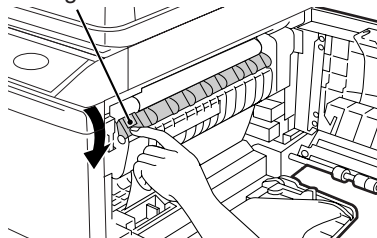

- 2 Gently remove the misfed paper from under the fusing unit as shown in the illustration. If the paper cannot be removed, proceed to "C: Misfeed in the transport area".**

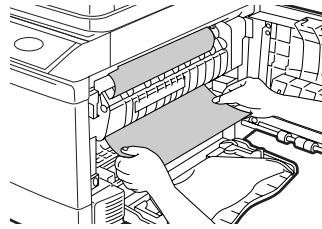

The fusing unit is hot. Do not touch the fusing unit when removing misfed paper. Doing so may cause a burn or other injury.



- Do not touch the photoconductive drum (green portion) when removing the misfed paper. Doing so may damage the drum and cause smudges on copies.
- Do not remove the misfed paper from above the fusing unit. Unfixed toner on the paper may stain the paper transport area, resulting in smudges on copies.

- 3 Raise the fusing unit release lever and then close the side cover by pressing the round projections near the side cover open button. The error indicator will go out and the ready indicator will light up.**

C: Misfeed in the transport area

- 1 Lower the fusing unit release lever.**

See "B: Misfeed in the fusing area" (p.71).

- 2 Open the front cover.**

To open the front cover, see "TONER CARTRIDGE REPLACEMENT" (p.74).

- 3 Rotate the roller rotating knob in the direction of the arrow and gently remove the misfed paper from the exit area.**

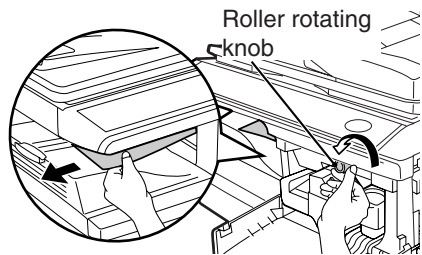

- 4** Raise the fusing unit release lever, close the front cover and then close the side cover by pressing the round projections near the side cover open button. The error indicator will go out and the ready indicator will light up.

**Caution**

When closing the covers, be sure to close the front cover securely and then close the side cover. If the covers are closed in the wrong order, the covers may be damaged.

D: Misfed in the RSPF (Option)

If the misfed original is at the top of the document feeder tray or in the exit area, follow procedure (A) to remove the misfed. If the misfed original is inside the document feeder and is not visible, follow procedure (B).

- (A)** If the misfed original is at the top of the document feeder tray or in the exit area, open the document feeder cover and pull out the original. If the original resists your pulling, press down on the RSPF jam release lever while pulling out the original. When finished, close the document feeder cover.

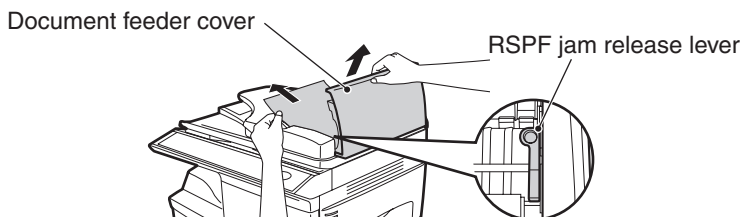

- (B)** Open the document feeder cover. Next, open the RSPF and rotate the roller in the direction of the arrow. If the misfed original is in the state (X), pull the original out as it feeds out into the exit area. If the misfed original is in the state (Y), pull the original down and out. When finished, lower the RSPF and close the document feeder cover.

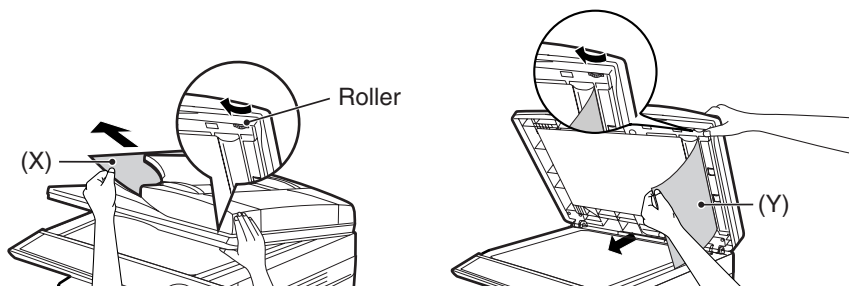
**Note**

Open and close the RSPF to clear the error indicator. "RETURN X ORIGINAL(S) START TO RESUME" will appear in the display. Return the indicated number of pages to the document feeder tray. Press the [START] key () to resume copying.

TONER CARTRIDGE REPLACEMENT

When toner is low, the error indicator will light up and "TONER CARTRIDGE IS NEAR EMPTY." will appear in the display to alert you to purchase a new toner cartridge. If copying is continued while the indicator is lit, copies will gradually become lighter until the toner runs out. When the toner runs out, the machine will stop operating, the error indicator will blink, and "REPLACE THE TONER CARTRIDGE" will appear in the display. Follow the procedure below to replace the toner cartridge.



- After the machine stops, it may be possible to make a few more copies by taking the toner cartridge out of the machine, shaking it horizontally, then reinstalling it. If copying is not possible after this operation, replace the toner cartridge.
- During a long copy run of a dark original, "TONER REPLENISHMENT IN PROGRESS" appears in the display, and the machine may stop even though toner is left. The machine will feed toner up to 2 minutes and then the ready indicator will light up. Press the [START] key () to resume copying.

-
- 1** Open the bypass tray, and then open the side cover while pressing the side cover open button.

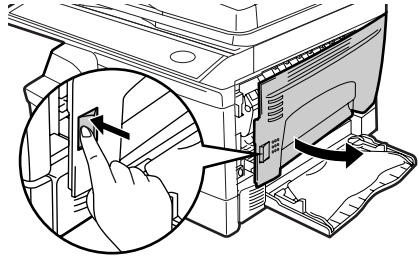

-
- 2** Push gently on both sides of the front cover to open the cover.

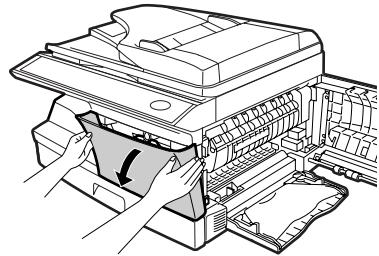

- 3 Gently pull the toner cartridge out while pressing the lock release lever.**

Toner cartridge lock release lever

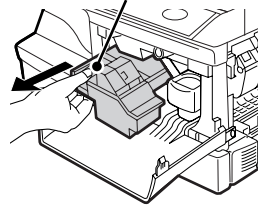

- After removing the toner cartridge, do not shake it or tap on it. Doing so may cause toner to leak from the cartridge. Put the old cartridge immediately in the bag contained in the box of the new cartridge.
- Dispose of the old toner cartridge in accordance with local regulations.

- 4 Remove the toner cartridge from the bag. Grasp the cartridge on both sides and shake it horizontally four or five times. After shaking the cartridge, remove the toner seal.**

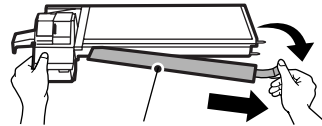
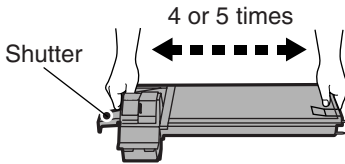

Toner seal



Grasp the toner cartridge as shown in the illustration. Do not hold the cartridge by the shutter. Be sure to only shake the cartridge before the toner seal is removed.

- 5 Gently insert the toner cartridge along the guides until it locks in place while pushing the lock release lever. Remove the tape from the shutter. Pull the shutter out of the toner cartridge as shown in the illustration. Discard the shutter.**

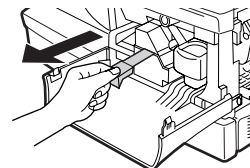
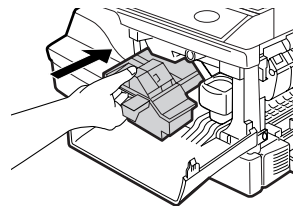

6 Close the front cover and then the side cover by pressing the round projections near the side cover open button. The error indicator will go out and the ready indicator will light up.

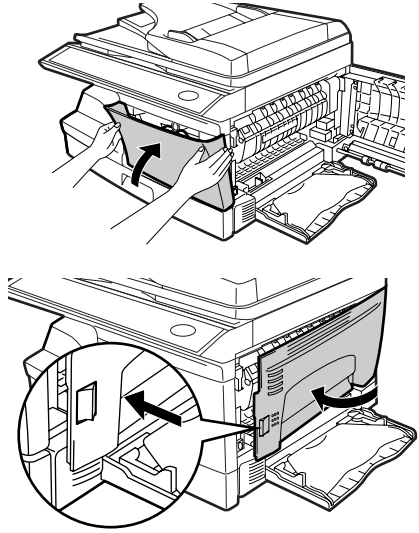

Caution When closing the covers, be sure to close the front cover securely and then close the side cover. If the covers are closed in the wrong order, the covers may be damaged.



Note Even after a new toner cartridge is installed, the start (⊙) indicator may not light up, indicating copying cannot be restarted (toner is not sufficiently fed). In this case, open and close the side cover. The copier will feed toner again approximately 2 minutes and then copying can be restarted.

SCAN HEAD LOCKING SWITCH

The scan head locking switch is under the original table. If the switch is locked (🔒), the machine will not operate. Unlock the switch (🔓) as shown below.

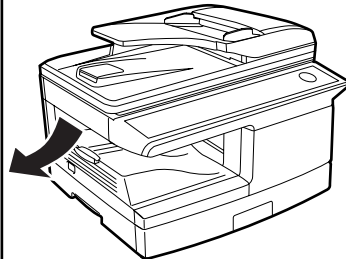
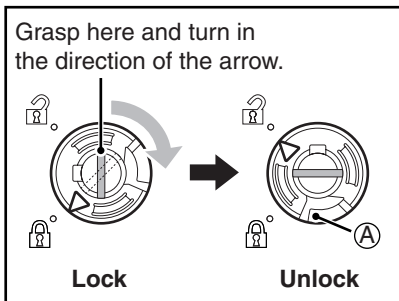

To lock the scan head locking switch, hold up the catch in illustration (A) and turn the centre knob counter-clockwise 90 degrees until you hear a click.

CHECKING THE TOTAL COUNT

You can check the total number of pages output by the machine (all pages printed by the copy function and printer function), as well as the output counts of each function (number of copies, number of scanned pages, number of faxes, etc.). When a count reaches 999,999 it returns to 0.

- 1** Press the [MENU] key.
Press the [◀] key (▼) or [▶] key (▲)
until "TOTAL COUNT" appears, and then
press the [ENTER] key.

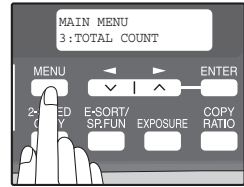

- 2** Press the [◀] key (▼) or [▶] key (▲) to
display the count of each function.

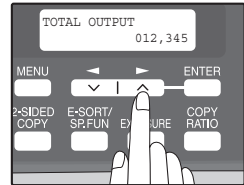

The count of each function changes as follows each the [◀] key (▼) or [▶] key (▲) is pressed:

- "TOTAL OUTPUT": Total number of pages output by the machine
- "COPIES": Total number of copies
- "SPF/RSPF":*1 Total number of pages scanned using the RSPF
- "2-SIDED PRINT": Total number of pages printed by two-sided print
- "PRINTS": Total number of pages printed the printer function
- "FAX":*2 Total number of sent and received faxes
- "FAX SEND":*2 Total number of sent faxes
- "SCAN SEND": Total number of scans
- "TONER REMAINING": The approximate amount of toner remaining in the toner cartridge is displayed as a percentage.

*1 When an RSPF is installed.

*2 When the optional Facsimile Expansion Kit is installed.

MAINTENANCE REQUIRED

When the error indicator will blink and "MAINTENANCE REQUIRED CALL FOR SERVICE" will appear in the display, service by an authorised SHARP service technician is required. Contact your authorised service representative as soon as possible.

CLEANING THE MACHINE

Proper care is essential in order to get clean, sharp copies. Be sure to take a few minutes to clean the machine on a regular basis.



Do not spray flammable cleaner gas. Gas from the spray may come in contact with the internal electrical components or high-temperature parts of the fusing unit, creating a risk of fire or electrical shock.



- Before cleaning, be sure to turn the power switch off and remove the power cord from the outlet.
- Do not use thinner, benzene or other volatile cleaning agents. Doing so may cause deformation, discoloration, deterioration or malfunction.

Cabinet

Wipe the cabinet with a soft, clean cloth.

Document glass and the back side of the original cover/RSPF

Stains on the glass, RSPF scanning window, cover or RSPF roller will also be copied. Wipe the glass, RSPF scanning window, cover and RSPF roller with a soft, clean cloth. If necessary, dampen the cloth with a glass cleaner.

Document glass/scanning window

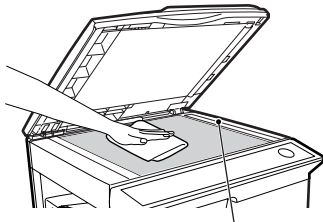

RSPF scanning window

Original cover/RSPF

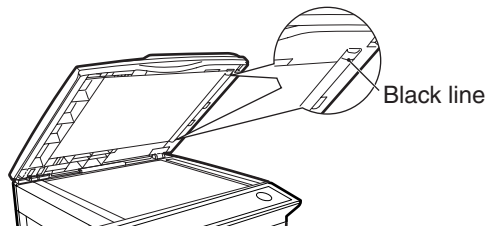
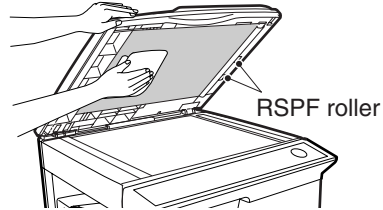

If this area is dirty, copying from the RSPF will not be possible.

Transfer charger

- 1** Turn the power switch off. (p.13)
- 2** Ensure that the bypass tray is open and then open the side cover while pressing the side cover open button.
- 3** Take the charger cleaner out by holding the tab. Set the charger cleaner onto the right end of the transfer charger, gently slide the cleaner to the left end, and then remove it. Repeat this operation two or three times.

**Note**

Slide the charger cleaner from the right end to the left end along the groove of the transfer charger. If the cleaner is stopped on the way, smudges on copies may occur.

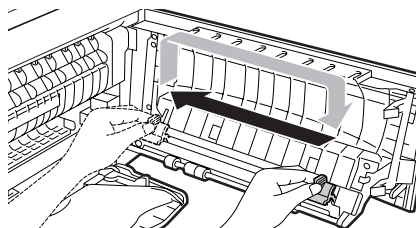
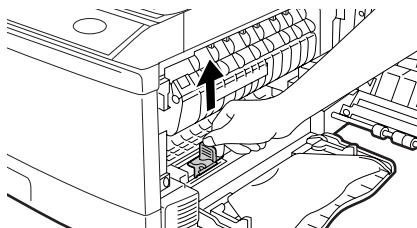

- 4** Return the charger cleaner to its original position. Close the side cover by pressing the round projections near the side cover open button.

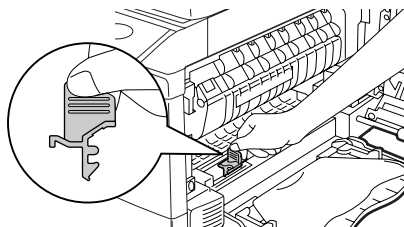

- 5** Turn the power switch on. (p.12)

SYSTEM CONFIGURATION

A number of options are available for the unit which allows you to configure a system to meet your particular needs. The options include the following.



Be sure to use only genuine SHARP parts and supplies.



For best copying results, be sure to use only SHARP Genuine Supplies which are designed, engineered and tested to maximize the life and performance of SHARP copiers. Look for the Genuine Supplies label on the toner package.

Facsimile
Expansion Kit
(AR-FX13)

Network
Expansion Kit
(AR-NB2 A)

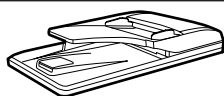

Reversing single pass
feeder (AR-RP9)



250-sheet paper feed
unit (AR-D33)

FACSIMILE EXPANSION KIT (AR-FX13)

This allows the machine to be used as a facsimile machine.

NETWORK EXPANSION KIT (AR-NB2 A)

This allows the machine to be used as a network printer/network scanner.

PS3 EXPANSION KIT (AR-PK1N)

This allows the machine to be used as a Postscript compatible printer.

REVERSING SINGLE PASS FEEDER (AR-RP9)

The reversing single pass feeder (RSPF) hold up 50 originals for automatic feeding. For the names of the parts of the RSPF, see "PART NAMES" (p.9).

250-SHEET PAPER FEED UNIT (AR-D33)

The paper feed unit provide the convenience of increased paper capacity for the unit and a greater choice of paper size readily available for copying.

The procedures for loading paper in the paper tray of paper feed unit, changing the paper size, and selecting the paper tray are same as for the paper tray in the unit. See "LOADING THE PAPER TRAY" (p.15) and "SELECTING THE TRAY" (p.23).

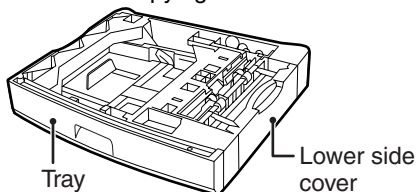

Using the AR-D33 with the printer function

To use the AR-D33 with the printer function, follow these steps to adjust the settings in the printer driver.



The printer driver cannot be set for use with the AR-D33 when opened from the application.

1 Click the "start" button.

2 Click "Control Panel", select "Printer and Other Hardware", and then click "Printer and Faxes".

- In Windows Vista, click "Control Panel", and then click "Printer".
- In Windows 98/Me/2000, select "Setting" and click "Printers".

3 Click the "SHARP AR-XXXX" printer driver icon and from the "File" menu select "Properties".

- In Windows Vista, from the "Organize" menu select "Properties".
- In Windows 98/Me, click the "SHARP AR-XXXX" printer driver icon, select "Properties" from the "File" menu, and then click the "Setup" tab.

4 Click the "Configuration" tab.

5 Select "Two trays" for "Input tray option", and click "OK".

The printer driver closes. This completes the settings needed to use the AR-D33.

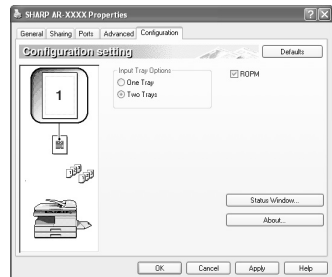

Interface cable

Please purchase the appropriate cable for your computer.

USB interface cable

USB cable that supports USB 2.0.

SPECIFICATIONS

Model	AR-M201
Type	Digital Multifunctional System, Desktop
Photoconductive type	OPC drum
Document glass type	Fixed
Copy/printing system	Dry, electrostatic transfer
Originals	Sheets, bound documents
Originals size	Max. 216 mm x 356 mm (8-1/2" x 14")
Copy size	Max. 216 mm x 356 mm (8-1/2" x 14") Min. 89 mm x 140 mm (3-1/2" x 5-1/2") Image loss: Max. 4 mm (11/64") (leading and trailing edges) Max. 4.5 mm (3/16") (along other edges in total)
Copying speed*1	20 copies/min. (A4 (8-1/2" x 11"), one-sided copying at 100% copy ratio)
Continuous copy	Max. 99 copies; subtractive counter
First-copy time*2	8.0 seconds (When user program 24 is set to OFF) 10.7 seconds (When user program 24 is set to ON) (paper: A4 (8-1/2" x 11"), exposure mode: AUTO, copy ratio: 100%)
Warm-up time*3	Approx. 0 sec.
Copy ratio	Document glass: Variable: 25% to 400% in 1% increments (total 376 steps) Fixed preset: 25%, 50%, 70%, 86%, 100%, 141%, 200%, 400% RSPF: Variable: 50% to 200% in 1% increments (total 151 steps) Fixed preset: 50%, 70%, 86%, 100%, 141%, 200%
Exposure system	Document glass: Moving optical source, slit exposure (stationary platen) with automatic exposure function RSPF: Moving original
Paper feed	One automatic feeding paper tray (250 sheets) + bypass tray (50 sheets)

Fusing system	Heat rollers
Developer system	Magnetic brush development
Light source	Cold cathode fluorescent lamp (CCD: 3 components; R, G, and B)
Resolution	Scan: 600 x 300 dpi Output: 600 x 600 dpi(AUTO/TEXT mode) Scan: 600 x 600 dpi Output: 600 x 600 dpi(PHOTO mode)
Gradation	256 tones (8 bits)
Power supply	Local voltage $\pm 10\%$ (For this machine's power supply requirement, see the name plate located on the back of the machine.)
Power consumption	Max. 1.0 kW
Space requirements (with trays extended)	802 mm (W) x 445 mm (D) (31.6" (W) x 17.6" (D))
Weight**4	Approx. 18.3 kg (40.3 lbs.)
Dimensions	518 mm (W) x 445 mm (D) x 298 mm (H) (20.4" (W) x 17.6" (D) x 11.8" (H))
Operating conditions	Temperature: 10°C to 30°C (50°F to 86°F) Humidity: 20% to 85%
Noise level	Sound Power Level Lwa(1B=10dB) Copying: 6.2[B] Standby: 3.2[B] Sound Pressure Level LpA (bystander positions) Copying: 48[dB(A)] Standby: 17[dB(A)] Sound Pressure Level LpA (operator position) Copying: 52[dB(A)] Standby: 17[dB(A)] Noise emission measurement in accordance with ISO 7779.
Emission concentration (measured according to RAL-UZ122 : Edition Jun. 2006)	Ozone: 1.5 mg/h or less Dust: 4.0 mg/h or less Styrene: 1.0 mg/h or less Benzene: 0.05mg/h or less TVOC(Printing): 10mg/h or less TVOC(Pre-Operating): 1mg/h or less

*1 When making multiple duplex copies, the copy speed will vary based on the environment conditions.

*2 The first-copy time is measured after the power save indicator turns off following power on, using the document glass with the polygon rotating in the copy ready state and "LSU SETTING" set to ON in the user programs (A4 (8-1/2" x 11"), paper fed from paper tray).

The first-copy time may vary depending on machine operating conditions and ambient conditions such as temperature.

The time from power on until the first copy is output varies depending on the installation site and the state of the machine in use.

*3 The warm-up time may vary depending on machine operating conditions and ambient conditions such as temperature.

*4 Not including toner cartridges.

Printer Function

Print speed*	20 ppm
Resolution	600 dpi
Memory	Approx. 30 MB
Emulation	SPLC (Sharp Printer Language with Compression)
Interface	USB 2.0 (Full-Speed/Hi-Speed compatible interface)
Interface cables	[USB cable] USB cable that supports USB 2.0. Please purchase a commercially available USB cable.

* When printing same document continuously on A4 (8-1/2" x 11") plain paper in non-offset mode, excluding processing time.

Scanner Function

Type	Flatbed scanner
Scanning method	Document glass/RSPF
Light source	Cold cathode fluorescent lamp (CCD: 3 components; R, G, and B)
Resolution	Basic: 600 dpi x 1200 dpi Setting range: 50dpi - 9600dpi
Original types	Sheet media, books
Effective scanning area	216 mm (8.5") (Lengthwise) x 356 mm (14") (Width)
Scanning speed	2.88 msec/line
Input Data	1 bit or 12 bit
Output Data	R.G.B 1 or 8 bits / pixel / A/D 16 bit
Scanning colours	Black and white 2 value, Greyscale, Full colour
Protocol	TWAIN WIA (Windows XP/Vista only) STI
Interface	USB 2.0 (Full-Speed/Hi-Speed compatible interface)
Drop out colour	Yes
Supported operating systems	Windows 98/Me/2000 Professional/XP/Vista (Detailed information can be found in "BEFORE INSTALLATION" (p.37))
Void area	None
Interface cables	[USB cable] USB cable that supports USB 2.0. Please purchase a commercially available USB cable.
Scanner utilities	Button Manager / Sharpdesk

Reversing single pass feeder (AR-RP9)

Acceptable originals	Weight: 56g/m ² to 90g/m ² (14 lbs. to 23.9 lbs.) Size: A5 to A4 (5-1/2" x 8-1/2" to 8-1/2" x 14") Capacity: Up to 50 sheets
Power supply	Drawn from the unit.
Weight (Approximately)	3.1kg (6.8 lbs.)
Dimensions	496 mm (W) x 358 mm (D) x 105 mm (H) 19.6" (W) x 14.1" (D) x 3.6" (H)

250-sheet paper feed unit (AR-D33)

Paper size	A5 to A4 (5-1/2" x 8-1/2" to 8-1/2" x 14")
Paper weight	56g/m ² to 80g/m ² (15 lbs. to 21 lbs.)
Paper capacity	One paper tray with capacity for 250 sheets of 80g/m ² (21 lbs. bond) paper
Weight	3kg (6.6 lbs.)
Dimensions	495 mm (W) x 395 mm (D) x 88 mm (H) (19.5" (W) x 15.6" (D) x 3.5" (H))
Power supply	Drawn from the unit



As a part of our policy of continuous improvement, SHARP reserves the right to make design and specification changes for product improvement without prior notice. The performance specification figures indicated are nominal values of production units. There may be some deviations from these values in individual units.

INDEX

Symbols

[#] key.....	10, 27, 29, 32
[◀] key	10
[▶] key	10

2

2 IN 1 copy	31
250-sheet paper feed unit	80, 86
[2-SIDED COPY] key	10, 27, 28

A

About the operation manuals	6
Appendix	82
Audible signals	60
Auto clear	12
Auto power shut-off mode	13
Automatic two-sided copying.....	26

B

Basic procedure for printing	50
Before installation	37
Button Manager	36
Bypass feed.....	17
Bypass tray.....	9, 17, 18, 70, 74
Bypass tray paper guides.....	9, 18

C

Cancelling a print job	50
Capacity of paper output tray	22
Caution	
- Handling the machine.....	4
- Label on the machine.....	3
- Selecting an installation site	3
- Using the machine.....	3
Changing a tray's paper size setting.....	19
Charger cleaner.....	9, 79
Checking the total count.....	77
Cleaning the machine	
- Cabinet.....	78
- Document glass.....	78
- Original cover/RSPF.....	78
- RSPF scanning window	78
- Transfer charger.....	79
[CLEAR ALL] key	11, 12, 50

[CLEAR] key

.....	10, 20, 21, 23, 29, 30, 50, 70
Connecting the machine to your computer	
- USB cable	42
Convenient copy functions	26
Conventions used in this manual and online manual	6
[COPY RATIO] key.....	11, 25

D

Display.....	10
Display messages	61
Document feeder cover	9, 73
Document feeder tray.....	9, 21
Document glass.....	9, 31

E

[ENTER] key.....	10
Envelopes.....	17
Environmental information.....	5
Error indicator.....	10, 61, 70
[E-SORT/SP.FUN] key	
.....	10, 29, 30, 31, 33, 34
Exit area	9
[EXPOSURE] key.....	10, 24
Exposure value guidelines	24

F

Facsimile expansion kit	80
Front cover	9, 72, 74
Fusing unit release lever	9, 71, 72

H

Handles	9
Hardware and software requirements	37
How to place the original	20
How to use the online manual	53

I		O	
Initial settings.....	12	Offset function during sort copy.....	30
Installing the software.....	36	Operation in copy, printer, and scanner modes.....	52
Interface cable.....	81	Operation panel.....	9, 10
Introduction.....	6	Optional equipment	80
L		Original guides	9, 21
Language setting.....	12	Original output tray extension.....	9, 22
Loading paper	14	Original types	24
Loading paper in the bypass tray	18	P	
Loading the paper tray	15	Paper.....	14
Long edge	26	Paper holder arm.....	9, 22
M		Paper output tray.....	9
Main features.....	7	Paper output tray extension	9, 22
Maintenance.....	61	Paper tray.....	9, 15
Maintenance required.....	77	Part names	9
Making copies	20	Photoconductive drum.....	9
Margin shift.....	34	Plug and play screen does not appear	68
Margin width	56	Power cord socket.....	9
[MENU] key	10	Power off	13
MFP driver.....	36	Power on	12
Misfeed removal		Power save indicator.....	10
- Fusing area	71	Power save modes.....	13
- Paper feed area.....	71	Power switch	9, 12, 13
- RSPF.....	73	Preheat mode.....	13
- Transport area.....	72	Preparations	9
Mode indicators	10	Printer driver.....	36
[MODE SELECT] key	10	Printer/scanner functions.....	49
N		Problems during setup of the software.....	67
Network expansion kit	80		
Normal copying			
- Document glass.....	20		
- RSPF.....	21		
Numeric keys.....	10, 23		

R

Ready indicator	11, 12, 76
Reduction/enlargement/zoom	25
Removing the software.....	69
Reversing single pass feeder	80, 86
Roller rotating knob	72
RSPF	9
RSPF indicator	10

S

Scan head locking switch	76
Scanner driver	36
Scanning from the operation panel ..	51
Scanning from your computer	52
Selecting a setting for a user program	59
Selecting the tray.....	23
Setting the number of copies.....	23
Setting up button manager	45
Sharpdesk	36
Short edge	26
Side cover	9, 70, 74
Side cover open button	9
Sort copy	29
Special papers.....	15
Specifications	82
[START] key	11, 20, 21
System configuration	80
System requirements for USB 2.0....	49

T

Toner cartridge	9, 74
Toner cartridge lock release lever	75
Toner cartridge replacement	74
Transfer charger.....	9
Tray location indicator	10, 61
[TRAY SELECT] key	10, 18, 23
Troubleshooting.....	61

U

USB connector	9, 42
User programs	
- Copy mode	54
- Print mode	58
User settings	54
Using the manual	6
Using the printer mode	50
Using the scanner mode	51

INDEX BY PURPOSE

Preparations

Paper, loading	
- Bypass tray.....	17
- Paper tray.....	15
Power, turn off.....	13
Power, turn on.....	12
Scan head locking switch, releasing.....	76
Tray's paper size, setting.....	19
User program, setting.....	54

Making copies

Copying	
- Document glass.....	20
- RSPF.....	21
Enlarging/reducing copies.....	25
Exposure, adjusting.....	24
Exposure, selecting.....	24
Setting the number of copies.....	23
Tray, selecting.....	23

Using convenient copy functions

2 IN 1 copying, using	
- Document glass.....	31
- RSPF.....	33
Automatic two-sided copying	
- Document glass.....	27
- RSPF.....	28
Margin shift, using.....	34
Sort copying, using	
- Document glass.....	29
- RSPF.....	30

Connecting the computer

Basic procedure for printing.....	50
Button Manager, setting up	
- Windows 98/Me/2000.....	47
- Windows XP/Vista.....	45
Installing the software.....	38
Online manual, using.....	53
Print job, cancelling.....	50
Printer mode, using.....	50
Scanner mode, using.....	51
Scanning from your computer.....	52
Scanning using the keys on the machine.....	51

Troubleshooting and maintenance

Checking the total count.....	77
Cleaning the machine	
- Cabinet.....	78
- Document glass.....	78
- Original cover/RSPF.....	78
- Transfer charger.....	79
Misfeeds, removing	
- Fusing area.....	71
- RSPF.....	73
- Paper feed area.....	71
- Transport area.....	72
Toner cartridge, replacing.....	74

MEMO

MEMO

Laser information

Wave length	780 nm +15 nm -10 nm
Pulse times	12.88 μ s \pm 12.88 ns/7 mm
Output power	Max 0.2 mW

At the production line, the output power of the scanner unit is adjusted to 0.18 MILLIWATT PLUS 5% and is maintained constant by the operation of the Automatic Power Control (APC).

Caution

Use of controls or adjustments or performance of procedures other than those specified herein may result in hazardous radiation exposure.

This Digital Equipment is CLASS 1 LASER PRODUCT (IEC 60825-1 Edition 1.2-2001)

CLASS 1 LASER PRODUCT

LASER KLASSE 1

LUOKAN 1 LASERLAITE

KLASS 1 LASERAPPARAT

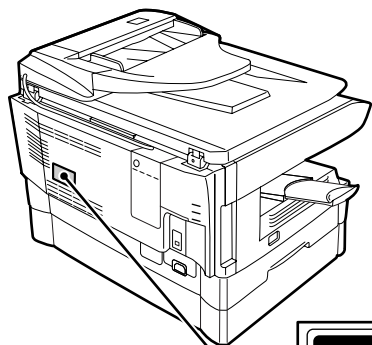

CLASS 1
LASER PRODUCT
LASER KLASSE 1

CAUTION

CLASS 3B INVISIBLE LASER RADIATION WHEN OPEN AND INTERLOCKS DEFEATED. AVOID EXPOSURE TO BEAM.

VORSICHT

UNSIHTBARE LASERSTRAHLUNG DER KLASSE 3B, WENN ABDECKUNG GEÖFFNET UND SICHERHEITSVERRIEGELUNG ÜBERERÜCKT. NICHT DEM STRAHL AUSSETZEN.

ADVARSEL

USYNLIG LASERSTRÅLING AF KLASSE 3B VED ÅBNING, NÅR SIKKERHEDSAFBRYDERE ER UDE AF FUNKTION. UNDGÅ UDSÆTTELSE FOR STRÅLING.

ADVERSEL

USYNLIG KLASSE 3B LASERSTRÅLING NÅR DEKSEL ÅPNES OG SIKKERHEDSLÅS BRYTES. UNNGÅ EKSPONERING FOR STRÅLEN.

VARNING

OSYNLIG LASERSTRÅLING KLASSE 3B NÅR DENNA DEL ÄR ÖPPNAD OCH SPÄRRAR ÄR URKOPPLADE. UNDVIK EXPONERING FÖR STRÅLEN.

VARO!

AVATTAESSA JA SUOJALUKITUS OHITETTAESSA OLET ALTTIINA NÄKYMÄTÖNTÄ LUOKAN 3B LASERSÄTEILYLLE. ÄLÄ KATSO SÄTEESEEN.

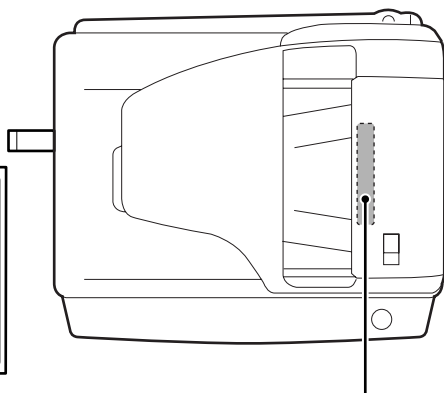

Laserstrahl

CAUTION
VORSICHT
ADVARSEL

CLASS 3B INVISIBLE LASER RADIATION WHEN OPEN AND INTERLOCKS DEFEATED. AVOID EXPOSURE TO BEAM.

UNSIHTBARE LASERSTRAHLUNG DER KLASSE 3B, WENN ABDECKUNG GEÖFFNET UND SICHERHEITSVERRIEGELUNG ÜBERERÜCKT. NICHT DEM STRAHL AUSSETZEN.

USYNLIG LASERSTRÅLING AF KLASSE 3B VED ÅBNING, NÅR SIKKERHEDSAFBRYDERE ER UDE AF FUNKTION. UNDGÅ UDSÆTTELSE FOR STRÅLING.

ADVERSEL
VARNING
VARO!

USYNLIG KLASSE 3B LASERSTRÅLING NÅR DEKSEL ÅPNES OG SIKKERHEDSLÅS BRYTES. UNNGÅ EKSPONERING FOR STRÅLEN.

OSYNLIG LASERSTRÅLING KLASSE 3B NÅR DENNA DEL ÄR ÖPPNAD OCH SPÄRRAR ÄR URKOPPLADE. UNDVIK EXPONERING FÖR STRÅLEN.

AVATTAESSA JA SUOJALUKITUS OHITETTAESSA OLET ALTTIINA NÄKYMÄTÖNTÄ LUOKAN 3B LASERSÄTEILYLLE. ÄLÄ KATSO SÄTEESEEN.

SHARP®

SHARP CORPORATION



This manual has been printed using a vegetable-based soy oil ink to help protect the environment.
Printed on 100% post-consumer recycled paper

PRINTED IN CHINA
2008C KS1
TINSE1869QSZZ